



Conserving energy for a better planet

ISOPIPE[®]



Complete Insulation Systems



These days, it's all about sustainability.

How can we make green buildings for the future?

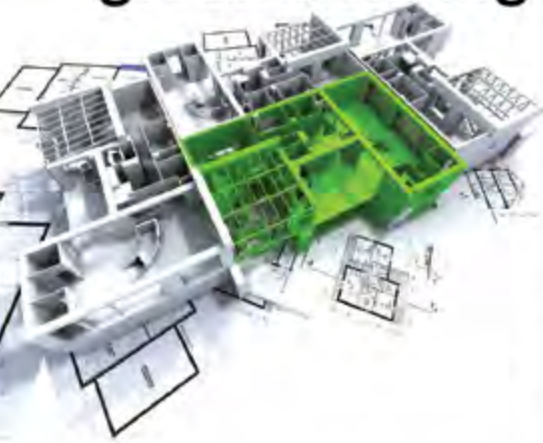

According to the EPA (US Environment Protection Agency), achieving sustainability is straightforward.

- Reduce the amount of natural resources buildings consume
- Reduce the amount of pollution emitted by those same buildings

High performance green buildings share three main attributes: high energy efficiency, low environmental impact and proper occupant health and comfort. These are the fundamentals for both new and existing buildings.

A simple measure that directly impacts these three attributes is the use of proper insulation systems

ISOPIPE is a highly durable insulation system. It has shown to offer improved environmental performance and advanced control of buildings.

ISOPIPE insulation systems are cost effective and energy efficient; you save money by conserving more than 80% of energy.

However, the real pay off comes when you consider ISOPIPE's environmental benefits:

- **Low thermal conductivity for effective energy saving and CO2 reduction.**
- **Zero ozone depletion potential (ODP)** ISOPIPE is manufactured without CFCs, HFCs or HCFCs in accordance with Green building requirements.
- **Zero Global Warming Potential (GWP)** ISOPIPE is manufactured with blowing agents which do not contribute to Global Warming.

Bare pipes lose heat. These losses can be significantly decreased when insulated with ISOPIPE

3i manufactures insulation systems according to the strictest standards that are environmentally sensitive in order to fulfill the need of our customers. We use raw materials and energy with responsibility to reduce waste. In addition, we meet industry standards by supplying information on the proper use of all our products to ensure their highest performance.



Invest in the future. ISOPIPE TC keeps people & the environment safe



The use of ISOPIPE products is an investment that brings many benefits besides the energy efficiency.

Poor air quality in buildings can have harmful effects on human health and the environment. The health effects caused by poor air quality mainly affect the body's respiratory and cardiovascular systems. These may range from subtle biochemical and physiological changes to difficulty in breathing and aggravation of existing respiratory and cardiac conditions.

ISOPIPE TC insulation systems are manufactured with respect to human health and environment as they ensure improved air quality

Moulds and fungi are easily found in nature and are necessary micro-organisms for the breakdown of leaves, wood and other plant debris. However inside buildings moulds and fungi can pose health risks. Mycotoxins, the by-products of mould, are toxic to humans. These toxins can slowly wear down the immune system and can lead to allergic or respiratory problems.

Furthermore, our insulation does not contain or release VOC (Volatile Organic Compounds) which are harmful substances for the environment.

The best method of prevention is the reduction of moisture in buildings. ISOPIPE TC insulation systems are designed to do exactly that.

ISOPIPE is manufactured without CFCs, HFCs or HCFCs in accordance with Green building requirements.



Bare pipes lose heat. These losses significantly decrease when insulated with ISOPIPE.

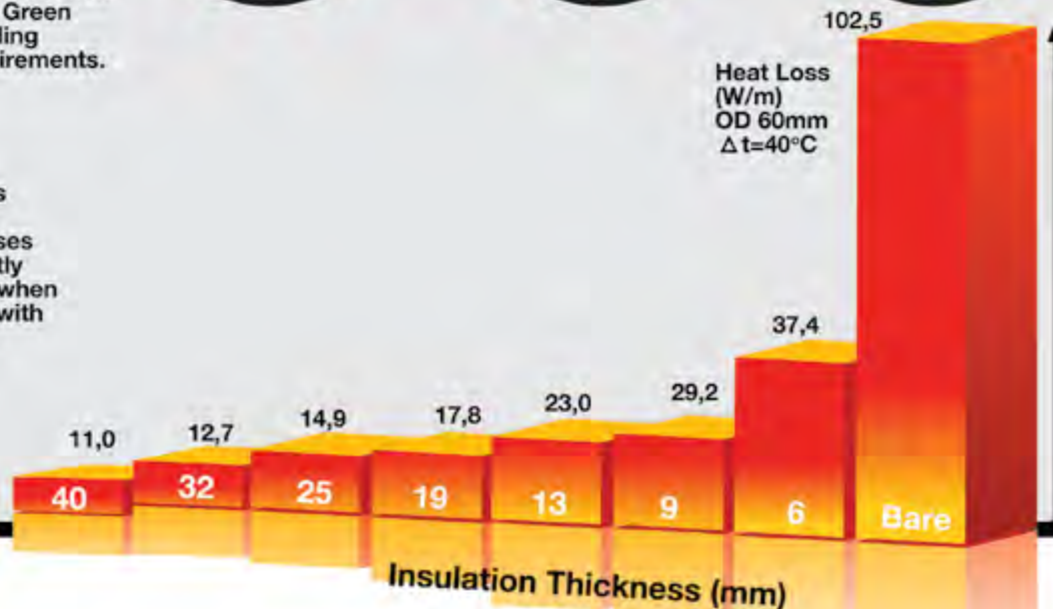

ISOPIPE TC insulation systems ensure improved air quality keeping people healthy and the environment suitable for living

Our specially designed calculation program determines the amount of energy savings according to insulation's thickness



Input Parameters

Material	Pipe
Environment	Indoor
Line Temperature	-20 °C / -4 °F
Ambient Temperature	20 °C / 68 °F
Humidity	75 %
Pipe Outer Diameter	60
Insulation Thickness	19



Surface Coefficient (indoor)
ID: ISOPIPE 19x6

A new generation of high performance insulation

The closed cell elastomeric insulation offers many benefits besides the energy efficiency. It prevents mould growth while it is condensation resistant.

Performance guaranteed through continuing supervision and factory tests.

Density
ISOPIPE TC insulation is produced with a density of 60-75 kgr/m³

Proper Fit
ISOPIPE TC provides a proper secure fitting around the pipe. This is especially important in applications like air conditioning, refrigeration or cooling, where condensation on the surface of the pipe is prevented.

Dust & Fibre Free

Operating Temperatures
Short temperature spikes—above recommended use—will not result in failure. (-40°C +105°C)

Flexibility
ISOPIPE TC has exceptional flexibility and elasticity. This allows for easy and fast application and effective insulation with excellent tear resistance.

Permeability
ISOPIPE TC's inherent structure & material offers a very high resistance to water vapour transmission. This ensures the long term performance & effectiveness of the insulation. ($\mu > 7000$)

Thermal conductivity
As air (closed cells) & elastomeric material are poor conductors of heat, ISOPIPE TC significantly reduces the transfer of heat. Thermal conductivity reaches the following values according to temperature.

- $\lambda = 0,035\text{W/mK}$ at 0°C
- $\lambda = 0,036\text{W/mK}$ at 10°C
- $\lambda = 0,037\text{W/mK}$ at 20°C
- $\lambda = 0,040\text{W/mK}$ at 40°C

Fire rating
ISOPIPE TC is fire resistant. It will not drip flaming particles nor will it spread flames. It provides safe insulation; an ideal choice for residential & public buildings. (Class 0, Class 1) B/s3/d0

Applicable in situations of :



The long term performance and efficiency of ISOPIPE significantly increases when installed according to the 3i technical guide.

Certifications

From the start, our commitment to quality and attention to detail has gained us international recognition. We do not only meet but exceed technical & performance specifications set by the insulation & fire safety standards. ISOPIPE has been highly commended by tradesmen, engineers & technicians alike for its ease of application, flexibility & durability. In 2000, The European Association of enterprises awarded ISOPIPE for its excellent quality.

All our certificates of quality, awards and documents of conformity to independent global institutes have been collected into a single book available for your convenience and reference.



Unique Applications

ISOPIPE TC insulation systems are proven solutions for marine applications. Due to their easy to clean nature, our insulation solutions are highly suitable for sanitary and hygienic environments. For these needs, we recommend our UV coated systems.



ISOPIPE TC with UV

Our specially developed polymer membrane cladding offers enhanced UV protection, vapour barrier and abrasive cover. It is a patented product (No.1004469) of 3i.

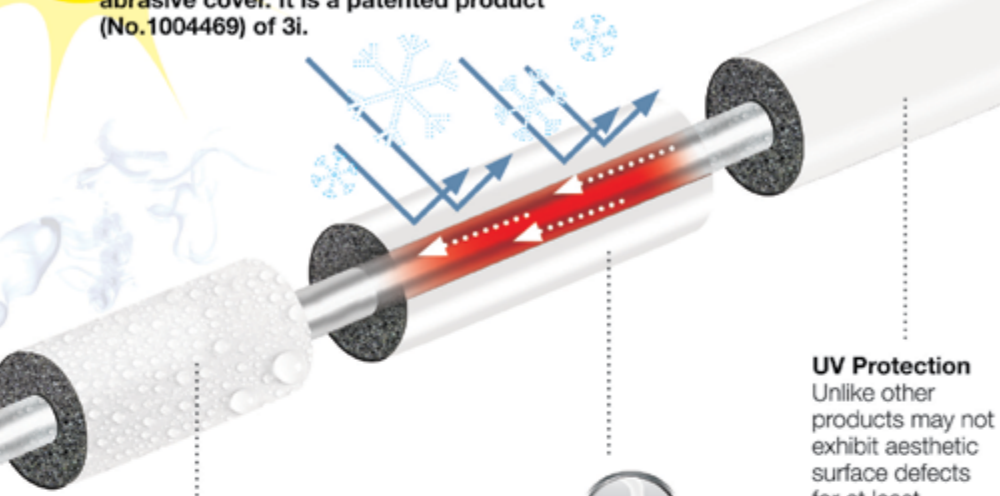

Permeability
Increased steam diffusion resistance (μ) more than 80%

Flexibility
Continuous long term performance

UV Protection
Unlike other products may not exhibit aesthetic surface defects for at least several years after prolonged exposure to UV radiation.

- Added Benefits**
- UV protection
 - Aesthetically pleasant
 - Oil and grease resistant
 - No need to tape, paint or cover

Temperature Resistance of UV Coating:
Up to 58°C
Estimated Lifespan: 3-5 years

ISOPIPE TC with UV PLUS

Closed cell elastomeric insulation coated with an aluminum outer cover composed of three layers polyester, aluminium and polyethylene which provides resistance both to ultraviolet rays and atmospheric agents

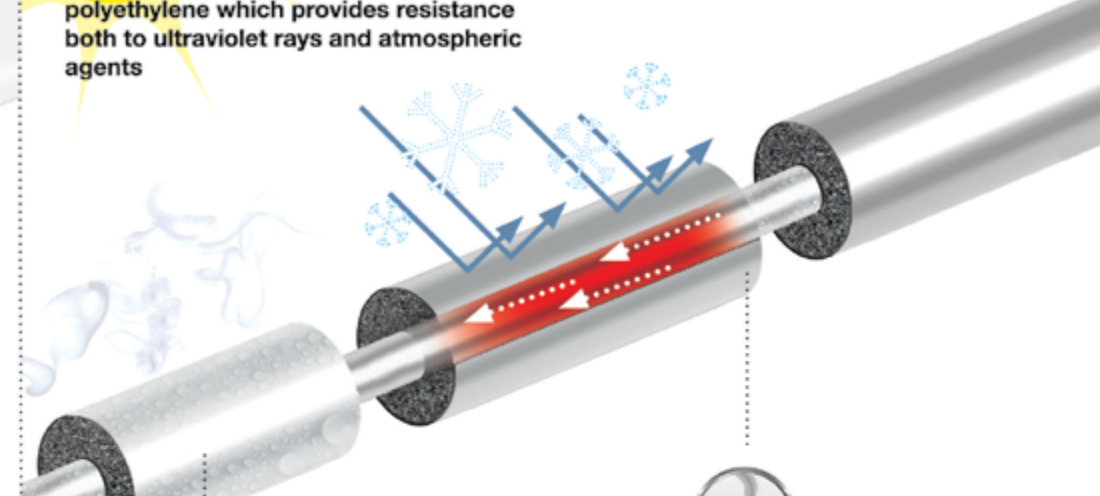

Increased steam diffusion resistance (μ) more than 100%

Flexibility
Continuous long term performance

- Added Benefits**
- High UV protection
 - Reduces risk of under insulation corrosion
 - Chemical and oil resistant

Thickness: 125 μ m
Weight: 135gr/m²

Temperature Resistance of UV Plus Coating:
-30°C + 85°C
Estimated Lifespan: +10 years

ISOPIPE TC Heavy Duty

Our superior aluminum covered insulation offers protection against mechanical damage, leakage and pipe corrosion. This is made possible by our heavy duty coating that is made of a double layer of aluminum, special UV protection and PVC backing.

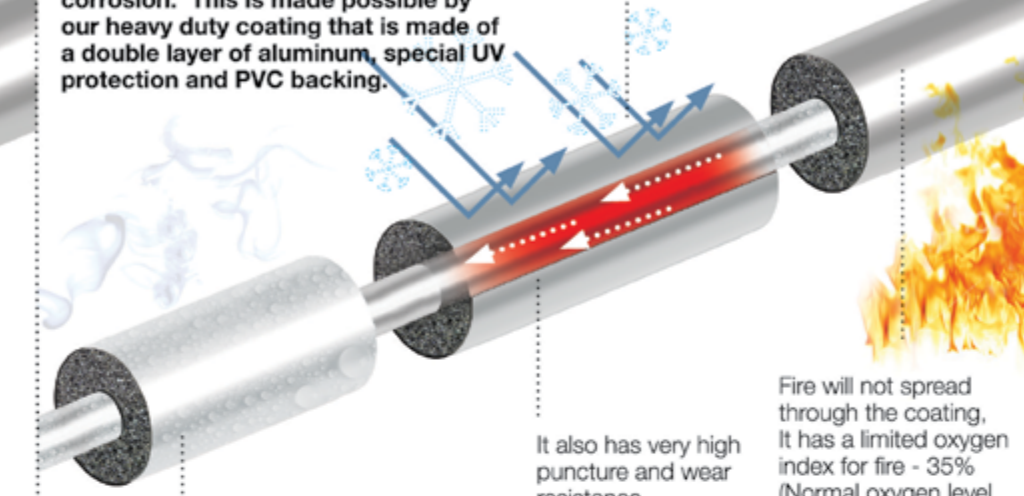

Excellent water vapour barrier

Permeability
Increased steam diffusion resistance (μ) more than 10 times

- Added Benefits**
- Saves time: Fast and easy installation.
 - User friendly: Easy to maintain.
 - No need to tape, paint or cover. Cleaned with a standard cloth.

Thickness: 230 μ m
Weight: 340gr/m²

You will save up to 50% on installation costs if you choose ISOPIPE TC Heavy Duty as this insulation comes with the aluminum coating in a unified piece.

- Stress free: It is fire retardant and reduces risk of under insulation corrosion.
- Saves money: Built to last by excellent long term UV protection and resistant to wear, chemicals, oil and severe weather.

Temperature Resistance of HD Coating:
-25°C + 75°C
Estimated Lifespan: +15 years

Applications



Coil

Effective ISOPIPE elastomeric foam insulation tube coiled in continued lengths of up to 78 meters.

It is highly practical to installers and technicians. No scraps; cut only the necessary length and store the rest. Less use for glue and less labour.

Available in: TC



Pipes

ISOPIPE is supplied in a complete range of sizes, which accommodate any application.

Available in pipes thickness of: 6, 9, 13, 19, 25, 30mm and to suit pipe diameters from 6mm to 139mm. Pipes standard length is 2 meters.

Available in: TC, UV, UV PLUS, HD



Slit & Seal

Angle-pre slit self-adhesive with overlapping self adhesive tape. Significantly reduces application and installation time and relevant labour costs. Secures bonding along the slit length, with strong double self-adhesive tape. Perfect for existing "installed" pipe systems.

Available in: TC



System

Sheet insulation system for large bore pipes, ducts and cylinders offers an efficient method of insulating as it is already accurately pre-cut to the dimensions of the pipe.

Engineered angle-cut ends assuring parallel to the pipe bonding. Less "unleash" stress. Packaged in 1 meter length.

Available in: TC, UV PLUS & HD



Sheets

Closed-cell elastomeric foam thermal insulation material in flat sheet form pre-cut in 2 meter length and 1 meter wide.

Available in: TC, UV PLUS & HD (with or without self-adhesive)



Rolls

Closed-cell elastomeric foam thermal insulation material in flat sheet form, rolled into length of up to 30 meters.

Available in: TC, UV PLUS & HD (with or without self-adhesive). TC is available in widths of 1m, 1,20m and 1,50m.

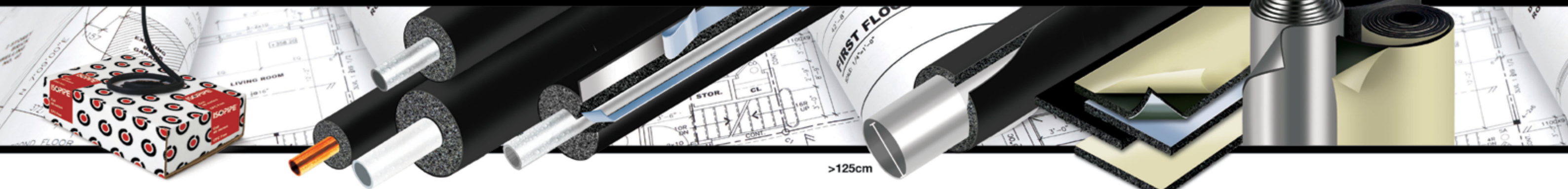

>125cm

3i has obtained the ability to produce specialised products due to its continuous research and development program.

Until today, elastomeric insulation has been vulnerable when used outdoors, and under specific weather conditions. To ensure its performance and lifetime this is ordinarily treated with paint or by wrapping the insulation with plastic type. Environmental and health issues were until recently overlooked.

Unlike other insulation, ISOPIPE is made to last. The R&D department of 3i, managed to combine the effective elastomeric insulation with a specially developed outer covering (polymer membrane), forming one unified body. This eliminates the need for any further external treatment or covering but maintains the flexibility, thermal performance and all other characteristics of the elastomeric insulation.

It is due to this continuous research and development that 3i are able to produce insulation systems that are both environmental and health sensitive without compromising the quality of the insulation performance.

Don't wait any longer to protect your investments. Join the world of 3i today and rest easy.



First in Innovation



Our 3i factory is situated 68km north of Athens, with a covered area of 40.000m² and building extensions of 28.000 m². Onsite, we have advanced testing equipment and continuous quality control that ensures top performance of all our products.

3i International Innovative Industries S.A.

GREECE

Head Offices:

Nafpliou & Daskalogianni
144 52, Metamorfossi, Athens, Greece
T: +30 210 28 28 603
F: +30 210 28 19 210
E: export@isopipe.gr

Plant:

68 km Nat. Road Athens - Lamia
341 00, Ritsona, Halkida, Greece
T: +30 2262 089800
F: +30 2262 072006

SPAIN

Calle Alfred Nobel, 29
Parcela, 35 - Poligono Industrial Valldoríof
08430 La Roca del Valles, Barcelona
T: +34 93 879 1195
F: +34 93 879 1313
E: info@isopipe.es

www.isopipe.eu

More products ranges from 3i

ISOPIPE[®] HT ISOTUBE[®] TORRENT[®]

The closed cell synthetic rubber solution for high temperatures. Environmentally friendly with limited smoke and toxic emissions in the case of fire.

ISOTUBE Pre-Insulated Pipes, Copper-Cu, Polyethylene-PE, Multilayer-PEX-AL-PEX and INOX is the ideal solution for cooling and thermo-plumbing works.

We supply TORRENT, the leader in cast iron boilers and manufacture Sun, Galaxy, Matrix, Star, Megastar and the compact unit Sun cast iron boilers from 25kw to 1400kw.

A wide range of accessories also available from 3i

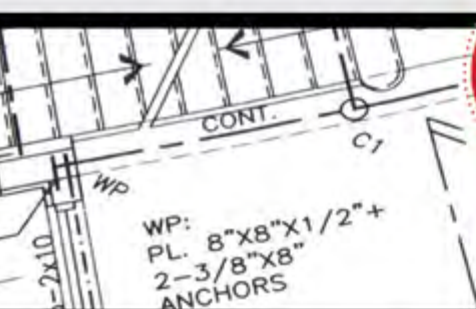

For all the technical specifications on the ISOPIPE TC range, refer to the ISOPIPE Technical Brochure.