



# ISOPIPE<sup>®</sup>

Integrated Insulation Systems

## Installation Guide



# ISOPIPE®

Integrated Insulation Systems

**Rebuild the future!**

[www.isopipe.eu](http://www.isopipe.eu)

	Page
<b>1. GENERAL INFORMATION</b>	
1.1 History	2
1.2 Certifications	4
1.3 ISOPIPE Insulation Calculator	5
<b>2. PRODUCTS INFORMATION</b>	
2.1 Applications	6
2.2 Product Range	7
2.3 ISOPIPE Insulation	8-9
ISOPIPE TC	8
ISOPIPE TR	8
ISOPIPE HT-HF	9
2.4 ISOPIPE Coverings	10-11
SOLAR COVERING	10
HP COVERING	10
UV PLUS COVERING	11
HEAVY DUTY COVERING	11
2.5 Accessories	12-15
ISOTAPE	12
ISOGLUE	14
ISOCLAMPS	15
ISOCOVER	15
<b>3. INSTALLATION GUIDE</b>	
3.1 Important Information	16-18
3.1.1 Terminology	16
3.1.2 Tool Kit	16
3.1.3 Important Notes Before Applying Insulation	17
3.1.4 ISOPIPE COVERINGS General instructions	17
3.1.5 ISOGLUE General instructions	18
3.1.6 Applying ISOTAPE & ISOCOVER	18

	Page
<b>3.2 Pipes</b>	<b>19-20</b>
3.2.1 Insulation on New Pipes	19
3.2.2 Bends	19
3.2.3 Installation on Existing Pipes	20
<b>3.3 Fittings, Connectors</b>	<b>21-29</b>
3.3.1 General Information	21
3.3.2 T-Joints	21
3.3.4 Bends	22
3.3.5 Curves	24
3.3.6 Joints	25
3.3.7 Valves	26
3.3.8 Multilayer Insulation Pipes	27
3.3.9 Installation On Concentric Reducers	27
3.3.10 Installation on Couplings	28
3.3.11 Insulation On Pipe Supports	28
3.12 Installation on Strainers, Strainer Valves, Inclined Seat Valves	29
<b>3.4 Sheets</b>	<b>30-32</b>
3.4.1 On Large Pipes (over 114 mm)	30
3.4.2 On Flat Surfaces on Pipes (over 600mm using ISOGLUE)	31
3.4.3 On Flat Surfaces Using Self-Adhesive ISOROLLS, ISOSHEETS	31
3.4.4 For Tanks with Dome Top	32



# 1.1 History



## 1997: The Beginning

- **ISOPIPE S.A.** is engaged in the production of the widely used closed cell synthetic rubber insulation under the trademark **ISOPIPE**. Our extensive product range includes **ISOPIPE TC**, **ISOROLLS**, **ISOSHEETS** and **ISOSYSTEM**.
- **ISOPIPE S.A.** plant is located in Ritsona area of Halkida - north of Athens, with a production area of 20,000 m<sup>2</sup> and 4,000 m<sup>2</sup> of buildings.



## 2000: Award Ceremony

- **ISOPIPE** insulation by **ISOPIPE S.A.**, received a quality excellence award by the EUROPEAN Business Organization.



## 2002: Factory Expansion

- **ISOPIPE S.A.** expanded its production facilities to a total covered area of 40,000 m<sup>2</sup> and buildings of 8,000 m<sup>2</sup>.



## 2006: Factory Expansion

- **ISOPIPE S.A.** further expanded its premises to a total covered area of 40,000 m<sup>2</sup> and buildings of 12,000 m<sup>2</sup>.



## 2007: Patented Product

- **ISOPIPE S.A.** introduced two new products, **ISOPIPE Slit & Seal** and **SOLAR Covering**.
- **ISOPIPE Slit & Seal**: Pre-slit pipe with self-adhesive tape and self-adhesive overlap.
- **SOLAR COVERING**: An absolute effective and reliable product for solar heating system, which combines the high-tech **ISOPIPE** insulation with our expertise in UV Covering, patented product.



## 2008: Boiler Production

- **ISOPIPE S.A.** produces cast iron boilers for central heating, under the name **TORRENT**. The boilers are produced in accordance with European Standards. The range includes boilers from 21,686 to 1,203,783 kcal/h or 25 to 1,400kw.
- **ISOSOL Pre - Insulated Pipes**  
The high quality and wide range of our bare pipe (INOX, Copper, PE and PERT-AL-PERT) in combination with **ISOPIPE S.A.**'s expertise in closed-cell synthetic rubber elastomeric foam, offer an ergonomic and highly functional product.

# 1.1 History



## 2009: Barcelona Spain Subsidiary

- **ISOPIPE S.A.** created a subsidiary in Barcelona, Spain, under the name ISOPIPE Ibérica sl.
- **ISOPIPE HT-HF** is an environmentally friendly halogen free product, for higher temperature applications (+175°C).
- **UV PLUS COVERING:** is an aluminum external protection covering composed of three layers of polyester, aluminum and polyethylene, thus providing resistance both to ultra violet radiation and other atmospheric agents.
- **HEAVY DUTY (HD) COVERING:** is a superior reinforced external aluminum protection covering, offering high resistance against mechanical damage, ultra violet radiation, leakages and pipe corrosion. The HEAVY DUTY COVERING consists of three layers of Polyester, Aluminum and Fire Resistant (FR) PVC.



## 2010: Factory Expansion

- **ISOPIPE S.A.** further expanded its facilities to a total covered area of 60,000 m<sup>2</sup> and buildings of 30,000 m<sup>2</sup>.



## 2011: Sound Absorption

- **ISOSOUND** is a new sound absorption and sound insulation product of high performance, specially designed for specific applications.



## 2015: TWIN SOLAR COVERING

- The patented product by **ISOPIPE S.A.** is now available in **TWIN**, which offers quick, easy and trouble free installation! The connection of the tubes is made through a special protective film, which allow easy separation at any desired length. Also available in **ISOSOL TWIN** with or without cable.



## 2016 - 2017: New Innovations

- **ISOPIPE S.A.** invests in high technology machinery, research and development and testing laboratories to improve the quality of its products and to introduce new products in the market.
- Our production process is now under EN ISO 9001:2015.



## 2017: TORRENT Condensing

- **ISOPIPE S.A.** introduced **TORRENT New Cast Iron Condensing Boilers**, Class A worldwide.
- **ISOPIPE Insulation Calculator**, a new user-friendly app is launched for Tablet & Mobile Devices.



## 2018: Madrid Spain Subsidiary

- **ISOPIPE ibérica sl** created a subsidiary in Madrid, Spain.



## 2019: London UK Subsidiary

- **ISOPIPE S.A.** created **ISOPIPE UK Ltd**, a subsidiary in London, UK.
- **ISOPIPE S.A.** launched **HP COVERING** which is a special aluminum covering for hygienic and internal applications.

# 1.2 Certifications



**ISOPIPE S.A.** is committed to supply the market with high quality products, always complying with the latest standards.

All declared attributes of our products are acknowledged by well known notified bodies. Moreover, all test reports are repeated periodically to ensure constant performance.

All our products possess a CE mark as a declaration that they comply with the requirements of the relevant European Health, Safety and Environmental Protection legislation.

All company procedures are explicitly described in the **Quality Management System of ISOPIPE S.A.**, which is certified according to **ISO 9001**. Several additional certifications, even some required for specific markets are available upon request. A book with the most commonly asked certificates of our products can also be provided to our partners.



# 1.3 ISOPIPE Insulation Calculator

## New User Friendly App for Tablet & Mobile Devices

### ISOPIPE<sup>®</sup> Insulation Calculator

**ISOPIPE Insulation Calculator** has been developed to offer exact measurements for Certified Insulation, **ISOPIPE TC** (NBR) and **ISOPIPE HT-HF** (EPDM). Through the Program's Calculations you receive many recommendations, but also the techno-economic choice towards energy savings.

#### ISOPIPE Insulation Calculator Highlights:

- ✓ The app **works Offline**, online use while sending the PDF file
- ✓ **Save** the **Calculation** inside the Program
- ✓ More than **2000** Calculations can be Saved and seen any time
- ✓ **Send** the Calculation in any **Email** address in PDF form
- ✓ **Send** Multiple Saved Calculations in a **Single PDF** file
- ✓ **Translated** in **8 languages**
- ✓ **Download** it for **free** in *Apple Store* & *Google Play Store*

Material  TC

Environment

Line Temperature °C: -20

Ambient Temperature °C: 20

Humidity %: 75

Pipe Outer Diameter (mm)

Insulation Thickness (mm)

Calculate

Clear

The calculation is based on Copper Pipe and Wall Thickness of 1 mm.

Calculator Calculations Products 3i Company

















For Online application use, please visit:  
<http://calculator.isopipe.eu>



# 2.1 Applications

ISOPIPE's unique applications.

Applications	Products											
	ISOPIPE TC	ISOPIPE TR	ISOPIPE HT-HF	SOLAR COVERING	UV PLUS COVERING	HP COVERING	HEAVY DUTY COVERING	SLIT & SEAL	ISOSOL TC	ISOSOL TC SOLAR	ISOSOUND	
 Antibacterial	✓	✓		✓ <sup>1</sup>	✓ <sup>1</sup>	✓ <sup>1</sup>	✓ <sup>1</sup>	✓	✓	✓		
 Chemical and Pharmaceutical			✓	✓ <sup>2</sup>	✓ <sup>2</sup>		✓ <sup>2</sup>					
 Cold Water	✓	✓	✓	✓	✓	✓ <sup>1</sup>	✓	✓	✓	✓	✓	
 Enclosed Spaces	✓	✓	✓									
 Renovation - Already Existing Applications								✓				
 Food Industry			✓	✓	✓	✓ <sup>1</sup>	✓					
 Heating & Plumbing	✓	✓	✓	✓	✓	✓ <sup>1</sup>	✓	✓	✓	✓		
 HVAC	✓	✓		✓ <sup>1</sup>	✓ <sup>1</sup>	✓ <sup>1</sup>	✓ <sup>1</sup>	✓	✓	✓		
 Low Temperature Cryogenic	✓	✓		✓ <sup>1</sup>	✓ <sup>1</sup>	✓ <sup>1</sup>	✓ <sup>1</sup>	✓	✓	✓		
 Refrigeration	✓	✓		✓ <sup>1</sup>	✓ <sup>1</sup>	✓ <sup>1</sup>	✓ <sup>1</sup>	✓	✓	✓		
 Schools & Hospitals			✓	✓ <sup>2</sup>	✓ <sup>2</sup>		✓ <sup>2</sup>					
 Ships & Trains	✓	✓		✓ <sup>1</sup>	✓ <sup>1</sup>		✓ <sup>1</sup>	✓				
 Solar Hot Water			✓	✓ <sup>2</sup>	✓ <sup>2</sup>		✓ <sup>2</sup>					
 Sound Absorbion											✓	
 Stadiums	✓	✓		✓ <sup>1</sup>	✓ <sup>1</sup>	✓ <sup>1</sup>	✓ <sup>1</sup>	✓				

<sup>1</sup> with ISOPIPE TC Insulation  
<sup>2</sup> with ISOPIPE HT-HF Insulation



# 2.2 Product Range



Pipes



Coil



Slit & Seal



System



Sheets



Rolls

**TC**

✓

✓

✓

✓

✓

✓

**TR**

✓

✓

**HT-HF**

✓

✓

✓

✓

**SOLAR**

✓

✓

✓

✓

✓

**HP**

✓

✓

✓

**UV PLUS**

✓

✓

✓

✓

**HEAVY DUTY**

✓

✓

✓

## 2.3 ISOPIPE Insulation

### ISOPIPE<sup>®</sup> TC Long-term and reliable thermal efficiency

ISOPIPE TC is a NBR based flexible elastomeric foam insulation with significantly high percentage, **98.5%**, of **closed - cells**. ISOPIPE TC ensures long-term and reliable thermal efficiency.



Properties	Technical Data
Thermal Conductivity (λ)	-20°C - 0.031 W/mk
	0°C - 0.033 W/mk
	20°C - 0.035 W/mk
	30°C - 0.036 W/mk
Permeability (μ)	≥7000
Operating Temperatures (°C)	Coil, Pipes, Slit & Seal: -50°C to +110°C
	System, Sheets, Rolls: -40°C to +85°C
Fire Rating (FR)	B-S3, d0
	Class 0, Class 1
	Class A or Class 1
	B <sub>1</sub> -S3, d0
Density (ρ)	60 Kgr/m <sup>3</sup> , ±10 Kgr/m <sup>3</sup>
Closed Cells	98.5%
Fungi & Bacterial Resistance	Passed
Noise Reduction	Up to 30dB
CFC, HFC, HCFC	Free
Odor	Neutral



- 98,5% Closed Cells
- 50°C to +110°C
- μ ≥7,000
- Nitrile Butadiene Rubber NBR
- E84 Class A EN 13501 B-s3, d0

The mentioned values are these which have been measured in our laboratory, under typical conditions. They can be modified without prior notice. You are kindly requested to assert their validity before any special use.

#### Product Range



### ISOPIPE<sup>®</sup> TR Less smoke Higher Performance

ISOPIPE TR is an NBR based flexible elastomeric foam insulation designed for building insulation and refrigeration systems. Its special formula provides **limited smoke propagation**, in case of fire and high vapour diffusion resistance, as well as high performance and protection against energy loss.



Properties	Technical Data
Thermal Conductivity (λ)	-20°C - 0.031 W/mk
	0°C - 0.033 W/mk
	20°C - 0.035 W/mk
	30°C - 0.036 W/mk
Permeability (μ)	≥10,000
Operating Temperatures (°C)	-50°C to +110°C
Fire Rating (FR)	B-S2, d0
Density (ρ)	60 Kgr/m <sup>3</sup> , ±10 Kgr/m <sup>3</sup>
Closed Cells	98.5%
Fungi & Bacterial Resistance	Passed
Noise Reduction	Up to 30dB
CFC, HFC, HCFC	Free
Odor	Neutral



- 98,5% Closed Cells
- 50°C to +110°C
- μ ≥10,000
- Nitrile Butadiene Rubber NBR
- B-s2, d0

The mentioned values are these which have been measured in our laboratory, under typical conditions. They can be modified without prior notice. You are kindly requested to assert their validity before any special use.

#### Product Range



# 2.3 ISOPIPE Insulation



Ecological Halogen-free Solution for Higher Temperatures

ISOPIPE HT-HF is an EPDM based, halogen free, closed cell synthetic rubber elastomeric foam for temperatures up to +175°C.

Properties	Technical Data
Thermal Conductivity ( $\lambda$ )	0°C - 0.040 W/mk 40°C - 0.045 W/mk
Permeability ( $\mu$ )	$\geq 4000$
Operating Temperatures (°C)	-50°C to +150°C (+175°C)
Fire Rating (FR)	Euroclass E
Density ( $\rho$ )	60 - 75 Kgr/m <sup>3</sup>
Noise Reduction	Up to 30dB
Halogen	Free
PVC-ODP zero	Free
CFC, HFC, HCFC	Free
Odor	Neutral

The mentioned values are these which have been measured in our laboratory, under typical conditions. They can be modified without prior notice. You are kindly requested to assert their validity before any special use.



## Product Range



ISOPIPE HT-HF is without:



## A wide range of Applications



## 2.3 ISOPIPE Coverings

### SOLAR COVERING

#### External Protection Covering against Harsh Weather & UV Radiation

**SOLAR COVERING** is a special polymer external protection membrane, offering resistance to ultra violet radiation and other atmospheric agents.

Available in White, Silver & Black Colour.

Available in Insulation of: ISOPIPE TC (+110°C) or ISOPIPE HT-HF (+175°C).

**Permeability:** Increased resistance to water vapour transmission.

**SOLAR Protection:** Its external surface may not exhibit aesthetic defects for at least several years after prolonged exposure to UV radiation.

**Flexibility:** Continuous long term performance.

**Temp. Range on Surface of Covering:** -40°C to +80°C

**Lifespan (est.):** +5 years

**Warranty:** 3 years



Also available in:

- **SOLAR SG:** a corrugated special polymer external protection membrane, available in Insulation of: ISOPIPE TC (+110°C)
- **SOLAR TWIN:** two connected tubes through a special protective film, allowing easy separation at any desired length

### HP COVERING

#### Hygienic Protection Covering, Ideal for Internal Use

**Hygienic Protection (HP)** is an aluminum special covering for hygienic and internal applications, composed of five layers. HP Covering is mainly used for duct wrap in HVAC systems and other fields, having excellent water vapour diffusion resistance and flame-retardant properties.

Available in Insulation of: ISOPIPE TC (+110°C)

**Thickness:** 60 µm

**Weight:** 154 g/m<sup>2</sup>

**Permeability:** Increased water vapour diffusion resistance (µ) by more than 100%.

**Flexibility:** Continuous long term performance.

**Temp. Range on Surface of Covering:** -35°C to +120°C

**Lifespan (est.):** +6 years

**Warranty:** 5 years



# 2.3 ISOPIPE Coverings

## UV PLUS COVERING

### Aluminum Protection Covering with High Reflective Properties

**UV PLUS COVERING** is an aluminum external protection covering composed of three layers of polyester, aluminum and polyethylene, which provides resistance both to ultra violet radiation and other atmospheric agents.

Available in Insulation of: ISOPIPE TC (+110°C) or ISOPIPE HT-HF (+175°C).

**Thickness:** 99 µm

**Weight:** 125 g/m<sup>2</sup>

**Permeability:** Increased water vapour diffusion resistance (µ) by more than 100%.

**Flexibility:** Continuous long term performance.

**Temp. Range on Surface of Covering:** -40°C to +100°C

**Lifespan (est.):** +10 years

**Warranty:** 5 years



## HEAVY DUTY COVERING

### Superior Aluminum Protection Covering with High Fire Resistance

**HEAVY DUTY (HD) COVERING** is a superior reinforced external aluminum protection covering, offering high resistance against mechanical damage, ultra violet radiation, leakages and pipe corrosion. The **HEAVY DUTY COVERING** consists of three layers of Polyester, Aluminum and Fire Resistant (FR) PVC.

Available in Insulation of: ISOPIPE TC (+110°C) or ISOPIPE HT-HF (+175°C).

**Thickness:** 230 µm

**Weight:** 340 g/m<sup>2</sup>

**Permeability:** Increased water vapour diffusion resistance (µ) by more than 10 times.

**Flexibility:** Continuous long term performance.

**Temp. Range on Surface of Covering:** -25°C to +75°C

**Lifespan (est.):** +15 years

**Warranty:** 7 years

**Cover Puncture:** Very high puncture and wear resistance. Fire will not spread through.

Ø 0.8 mm = 23 N

Ø 2.0 mm = 87 N



# ISOTAPE® 2.3 Accessories

## Self-adhesive Insulation Tape

Closed cell structure with antimicrobial product protection

Pressure sensitive rubber insulation tape ideal for pipes, fittings and other tight areas where pipe insulation cannot be applied. Appropriate for cold and hot water applications.

Self adhesive reinforced with mesh scrim for extra support.



Available in Black colour

Description	Length	Width	Packaging
	m	mm	Unit/ Ctr
TC Insulation S/A tape	10 m	50 mm	10
TC Insulation S/A tape	15 m	50 mm	10
TC Insulation S/A tape	30 m	50 mm	10

Units per carton can be amended without notification.

## SOLAR Polymer

Specially designed self adhesive tape for excellent weather and UV protection

Specially designed self adhesive tape, to be combined with SOLAR COVERING. Provides excellent weather and UV protection as well as permeability resistance.



Available in Silver, Black and White colour

Description	Length	Width	Packaging
	m	mm	Unit/ Ctr
SOLAR Polymer	10 m	50 mm	24
SOLAR Polymer	25 m	50 mm	24

Units per carton can be amended without notification.

### PVC

#### Strong and durable tape, based on premium grade PVC film

Based on a premium grade Plasticized Polyvinyl Chloride (PVC) film, coated with a non-thermosetting rubber-resin adhesive with good aging characteristics. Designed to be highly conformable and pursuant by moisture and other chemicals.

Description	Length	Width	Packaging
	m	mm	Unit/ Ctr
White PVC	33 m	50 mm	40
Black PVC	33 m	50 mm	40

Units per carton can be amended without notification.



Available in Black and White colour

### UV PLUS Pet-Al-Pe

#### Very strong & durable tape with excellent mechanical properties, in aluminum colour

Aluminum tape with high resistance to UV rays and atmospheric agents, specially designed for combination with UV Plus Covering.

Description	Length	Width	Packaging
	m	mm	Unit/ Ctr
UV PLUS Pet-Al-Pe	10 m	50 mm	24
UV PLUS Pet-Al-Pe	25 m	50 mm	24

Units per carton can be amended without notification.



Available in Aluminum colour

## 2.3 Accessories

### ISOGLUE® 255

#### High Quality glue for rubber insulation

ISOGLUE 255 is a solvent based contact adhesive designed specially for uniform and safe seam bonding of flexible insulation materials like elastomeric pipes and sheets applied on high temperature lines. Suitable for application on pipes and tanks with service temperatures up to **120°C**.



Description	Packaging
	Unit/ Ctr
ISOGLUE 250 ml with brush	20
ISOGLUE 500 ml	12
ISOGLUE 1000 ml	12
ISOGLUE 1 gallon	5

Units per carton can be amended without notification.

Fully compatible glue for joining ISOPIPE TC, ISOPIPE TR and ISOPIPE HT-HF insulation.

### ISOGLUE® HT 150

#### High Quality glue for rubber insulation



ISOGLUE HT 150 is a solvent based (Toluene Free) contact adhesive designed specially for uniform and safe seam bonding of flexible insulation materials like elastomeric pipes and sheets applied on high temperature lines. Suitable for application on pipes and tanks with service temperatures up to **150°C**.



Description	Packaging
	Unit/ Ctr
ISOGLUE HT 150 250 ml with brush	20
ISOGLUE HT 150 500 ml with brush	12
ISOGLUE HT 150 1000 ml with brush	12

Units per carton can be amended without notification.

Fully compatible glue for joining ISOPIPE TC, ISOPIPE TR and ISOPIPE HT-HF insulation.



# ISOCLAMPS

## Eliminating Insulation Gaps

**ISOCLAMPS** are used to eliminate insulation gaps and reduce the possibility of thermal bridge, during the support of the insulated tubing (made by collar or metal bracket), in refrigeration or heating installations. They are suggested for applications where the temperature is between **-45°C to 105°C**.

**Type of Material:** Polyurethane (PU) foam with rubber insulation on both sides and PVC covering, with self- adhesive.

Available in thickness of: **13, 19, 25 & 32 mm** and pipe diameters up to **139 mm**. Other sizes available upon request.



Delivered with or without metal clamps. The metal clamps are M8 - M10.

# ISOCOVER

## Insulation Protection Covering

**ISOCOVER** is a special insulation protection covering against UV Radiation and mechanical damages.

Available in **SOLAR, HP, UV PLUS** and **HEAVY DUTY (HD)**.

Description	Length	Width	Packaging
	m	mm	Unit/Crt
Solar	10 m	1 mm	1
Solar	25 m	1 mm	1
UV PLUS Pet-Al-Pe	10 m	1 mm	1
UV PLUS Pet-Al-Pe	25 m	1 mm	1
HEAVY DUTY Pet-Al-PVC	10 m	1 mm	1
HEAVY DUTY Pet-Al-PVC	25 m	1 mm	1

Units per carton can be amended without notification.

**Ideal solution for insulation protection in confined working areas and for already installed pipe systems**



# 3.1 Important Information

## 3.1.1 Terminology

- **Insulation:** Isopipe Rubber closed cell flexible material in tubes or sheets
- **Pipe-line:** is the main body of pipe work, can be copper, steel or plastic or composite pipes
- **Joints:** screwed, welded, valves or any other part used to join pipe-lines
- **Pipe size:** commonly referring to the external diameter of pipe
- **Internal Tolerance:** referring to the min and maximum tolerances within the internal diameter of the insulation (di)
- **Clutch:** the act of clamping a sliced insulation over a pipe
- **Insulation surfaces:** the smooth flat side of the insulation, defined by length and width
- **End:** is the thickness side of the insulation (picture), defined by thickness (Th)
- **Fitting cover:** cut, slit and formed into shape parts of insulation, used for Joints and bends
- **Touch - Dry:** After applying glue, the point in time where the solvent has evaporated and the glue partly dried, to a point when touched (finger) it will not come-off(stick) to the finger. Can range between 3-10 minutes depending on temperature and humidity
- **Line temperature:** the temperature of the liquid inside the pipe (t)
- **Ambient temperature:** the environmental temperature surrounding the pipe ( $t_a$ )
- **Relative humidity:** the level of humidity surrounding the pipe (h)

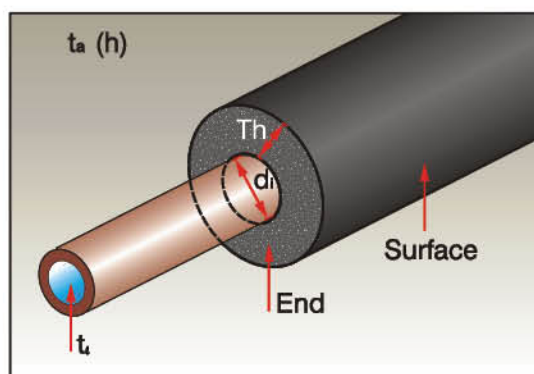

## 3.1.2 Tool Kit

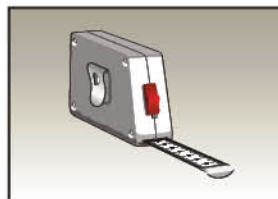

1. Tape measure

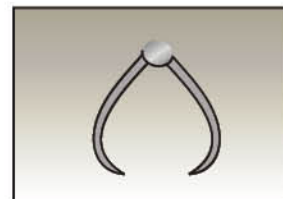

2. Calipers

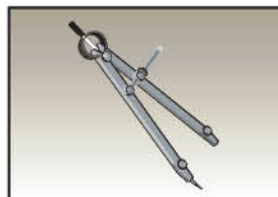

3. Compass

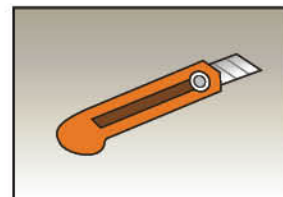

4. Knife



5. Brush

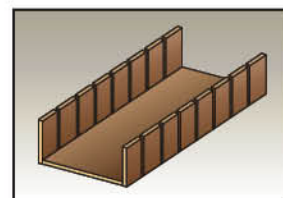

6. Miter box or angle diagram, for cutting angles



7. Spatula



8. ISOTAPE



9. ISOGLUE

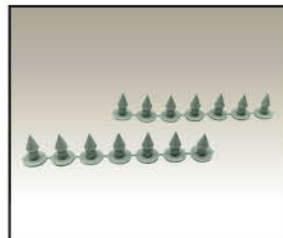

10. Rivets

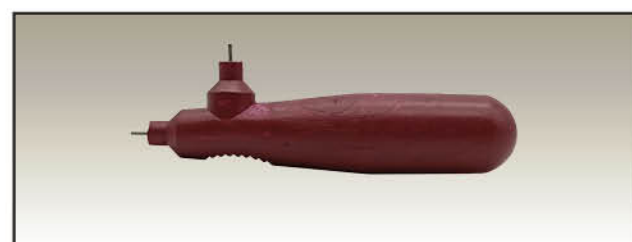

11. Rivet Tool

# 3.1 Important Information

## 3.1.3 Important Notes Before Applying Insulation

1. Always use the proper size insulation depending on application parameters, i.e. pipe size, fluid temperature, ambient temperature, relative humidity, and assure that the internal tolerances of the pipe are appropriate to the pipe been insulated. i.e. a pipe of External diameter 15mm would require internal diameter of 16mm 17,0mm, ensuring easy application and snug fit.

External pipe diameter	The ideal tolerances of insulation above the external diameter of the pipe
Φ 6 - Φ 64	+1,0mm - 2,0mm
Φ 67 - Φ 89	+1,0mm - 3,0mm
Φ 101 - Φ 139	+2,0mm - 4,0mm

2. Never stretch or compress **ISOPIPE** insulation.
3. Never insulate pipe-work that is in operation.
4. Use clean **ISOPIPE** insulation on clean and dry pipe-work remove any water, powder, dust, dirt or oil from both insulation and Pipe.
5. Never Insulate 2 pipes together within the same insulation and always allow gap of at least 20mm between insulated pipelines for free air circulation.
6. Seal all seams, valves, and joints. Do not allow open ends.
7. Use sharp knives and fresh glue.
8. Use adequate anti-corrosion protection on steel surfaces.
9. Common Fastening tape is not recommended as protective cover.
10. **For outdoor applications, there are 3 types of rubber insulation protection available.**
  - **SOLAR Covering** (See page 10)
  - **UV PLUS Covering** (See page 11)
  - **HEAVY DUTY (HD) Covering** (See page 11)
11. **For indoor applications use HP Covering** (See page 10)

## 3.1.4 ISOPIPE COVERINGS

### General instructions

1. When you cut and join an **ISOPIPE COVERING**, avoid placing the joints of the sections towards the sun, to prevent direct contact with UV radiation.
2. When using/ installing **SOLAR, HP, UV PLUS** or **HEAVY DUTY** protection, use the appropriate tape, **ISOTAPE series** or **ISOCOVER series** (See Section 2.3, Pages 12-13 & 15), to secure the sealing.
3. When using/ installing **UV PLUS Covering**, pay attention, so that no air will be trapped inside the joints. Follow the instructions below:
  - Peel off the protective release film (yellow colour).
  - Use **ISOPIPE** Spatula to prevent the air trap during the joint procedure.
  - Use **ISOCOVER** tape to seal the joint.

The same instructions applies for SOLAR & HP Coverings by using the appropriate tape series (See page 18).

4. When using/ installing **HEAVY DUTY Covering**, follow the instructions below:
  - Peel off the protective release film (yellow colour).
  - Use **ISOPIPE** Spatula to avoid creating any air bubbles during the joint procedure.

Since **HEAVY DUTY Covering** is a "hard" cladding, it is really important to use Rivet Tool and Rivets, to avoid unsealing. Please follow the instructions below by choosing a or b:



a. Punch a hole into the foil with the rivet tool, then plug the rivet into the metal tip of the tool and push it into the hole.

b. Place the rivet tool, with the metal tip, into the rivet and push the rivet directly through the foil.

### Notice:

1. Rivets should be placed between 100 to 150mm apart. However, when cladding takes place over short lengths, for example 200mm, ensure the ends of the jacket are well secured; and place another rivet in the middle. 
2. Do not punch the rivet too close to the edge of the jacket as it may break. Allow a minimum of 10mm distance. Pay also attention to the cold temperatures; it's best to firstly test on some scrap material and then on the finished jacket.

After finishing, for better aesthetic result, use **ISOCOVER** tape.

The same instructions of **HEAVY DUTY** Covering applies for **ISOCOVER HEAVY DUTY Pet-AI-PVC**.

# 3.1 Important Information

## 3.1.5 ISOGLUE

### General instructions

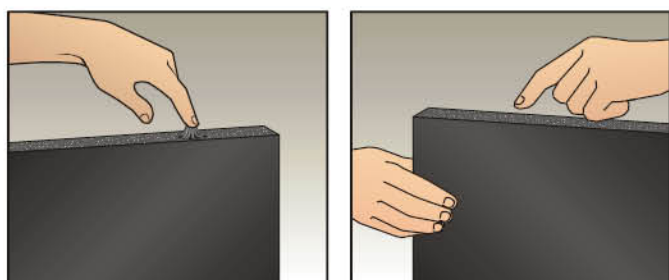

1. Apply an even layer of glue on both ends of insulation
2. Allow to touch-dry
3. Bring together firmly.

### Note

**ISOGLUE** has a black colour which gives a perfect visual result after applying

- Approximately 200ml needed per square meter (m<sup>2</sup>) of gluing.
- It is important that the layer of glue is even, without formed blots, as this may cause crystallization and not proper bonding.
- **ISOGLUE** is flammable, so keep away when soldering or torching.
- Keep away from flame, sparks and heat.
- Always, keep glue container tightly closed to prevent evaporation.
- Isogluce bonds immediately upon contact, so ends must be put together accurately.
- Allow for 36 hrs before operation (especially for hot temperature).
- Always keep cans tightly sealed, preferably use fresh glue and in small cans to avoid risk of glue thickening.
- Stir glue before opening.
- The tack time for **ISOGLUE** is from four (4) to ten (10) minutes, depending on temperature and humidity. The maximum adhesive performance is achieved when the glue's solvent has evaporated. This can be practically detected by touching the surface with a finger. If the glue does not stick to the finger, and the glue does not feel sticky, then the joint may be closed.
- The best installation temperature is between 15-20 degrees.
- In cold temperature less than 5 degrees warm glue up in bucket of hot water.
- For cold pipe applications only, it is recommended to seal (glue) the pipe section ends onto the pipeline.

## 3.1.6 Applying ISOTAPE & ISOCOVER

**Measuring the circumference:** When using a tape measure, make sure to allow for considerable length equivalent to cover the thickness of the insulation itself. A practical approach is to use a strip of insulation of the same thickness to measure circumference and mark where the two ends overlap.



When applying any type of tape, use **ISOPIPE** Spatula to avoid creating any air bubbles during the joint procedure.

### Notice:

In the end of any installation, it is really important to use the appropriate tape for each insulation especially when using Coverings.

Covering	Tape
<b>SOLAR</b>	ISOTAPE SOLAR POLYMER
	ISOTAPE PVC
<b>HP</b>	ISOCOVER HP
<b>UV PLUS</b>	ISOTAPE UV PLUS Pet-AI-Pe
	ISOCOVER UV PLUS Pet-AI-Pe
<b>HEAVY DUTY</b>	ISOTAPE UV PLUS Pet-AI-Pe
	ISOCOVER HEAVY DUTY Pet-AI-PVC

### Notice:

When using ISOPIPE TC, ISOPIPE TR, ISOPIPE HT-HF use ISOTAPE Self-Adhesive.

The same instructions apply when using a different product range including Slit & Seal, ISOROLLS, ISOSHEETS, ISOSYSTEM by using the appropriate tape.

**The tape should be applied over the glued ends/joints.**

For ISOCOVER HEAVY DUTY Pet-AI-PVC installation please advise page 17.

## 3.2 Pipes

### 3.2.1 Insulation on New Pipes

The following instructions also apply with ISOPIPE TC/ HT-HF/ TR, ISOPIPE TC/HT-HF SOLAR, ISOPIPE TC HP, ISOPIPE TC/HT-HF UV PLUS, ISOPIPE TC/HT-HF HD.

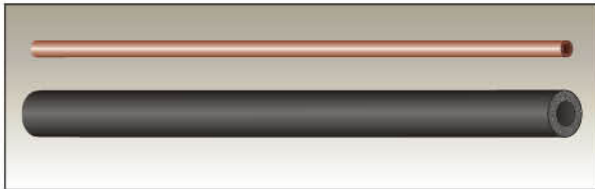

1. Wipe clean any dust, dirt or grease from the pipe.
2. Cut the insulation as long as or slightly longer than the length of the pipe-section been installed.
3. Slide the **ISOPIPE** insulation gently through the pipe; push the insulation over the pipe rather than pull

For pipes over 114mm it is recommended to use ISOROLLS, ISOSHEETS or ISOSYSTEM.

### Joining lengths of ISOPIPE

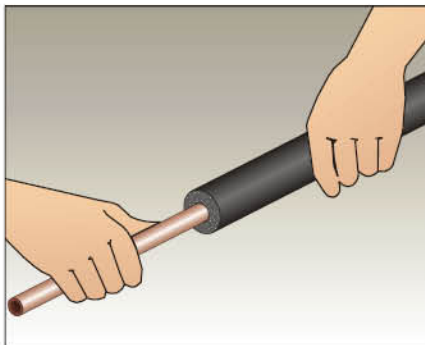

1. Apply glue on both ends of insulation.
2. Allow glue to touch dry.

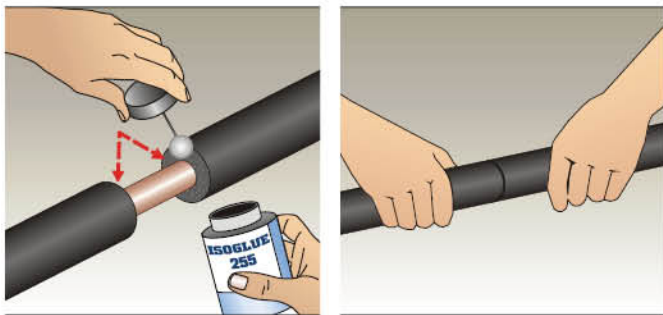

3. **Bring together firmly.** For additional sealing at the ends of pipe sections, for cold applications only to reduce risk of condensation, seal by gluing the insulation onto the pipe.

### 3.2.2 Bends

**ISOPIPE** insulation is very flexible and can easily be slid over bends and turns.

However, on sharp bends and joints kinking and stretching of insulation may occur which will affect the insulation performance.

It is advised in this instance to cut and glue pipe as picture below, relieving the stress on the pipe at sharp bends.

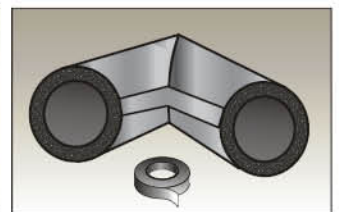
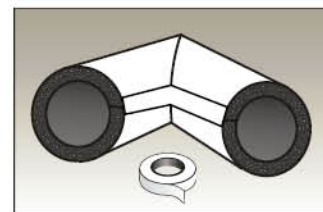
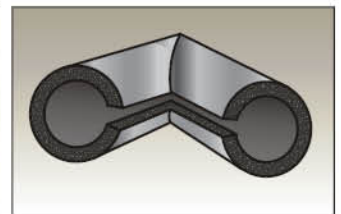
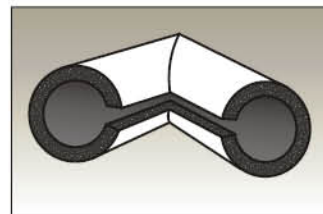
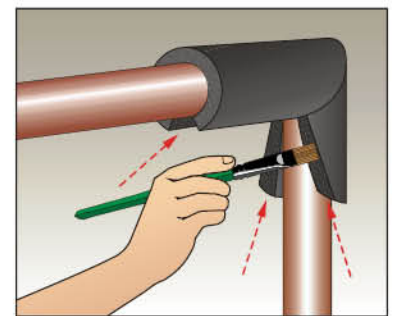
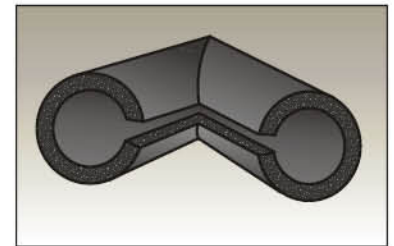
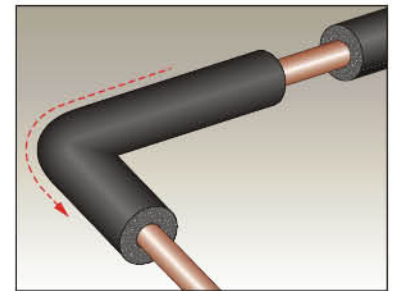

When using **SOLAR, HP, UV PLUS & HEAVY DUTY** protection follow the same instructions and upon finishing use the appropriate tape (See Section 3.1.6, Page 18).

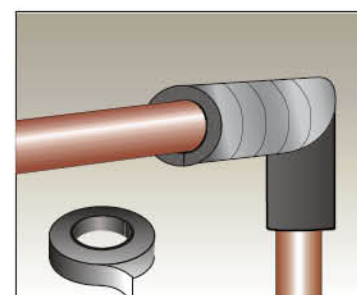

# 3.2 Pipes

## 3.2.3 Installation on Existing Pipes

### a) The snap on method

The following method is used for applying insulation on already installed and connected pipes, using ISOPIPE TC/ HT-HF/ TR, ISOPIPE TC/HT-HF SOLAR, ISOPIPE TC HP, ISOPIPE TC/HT-HF UV PLUS, ISOPIPE TC/HT-HF HD.

1. Use a sharp knife to slit the **ISOPIPE** lengthwise on one side.
2. Cover the pipe

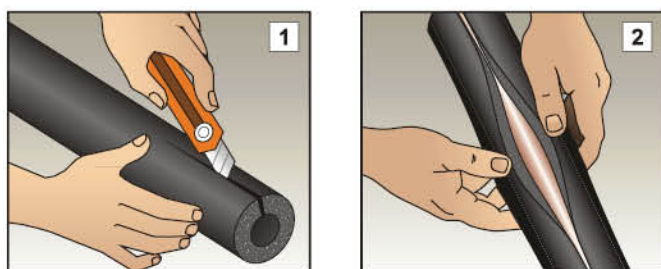

3. Apply **ISOGLUE** adhesive on both slit surfaces. Keep the adhesive-covered sides apart for drying.
4. Press both sides together firmly in order to connect them all the way.
5. If the insulation sticks to the pipe, loose the insulation as shown.

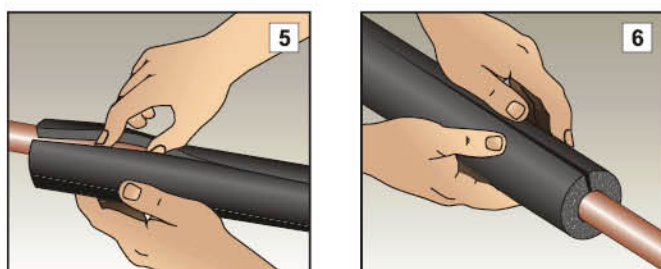
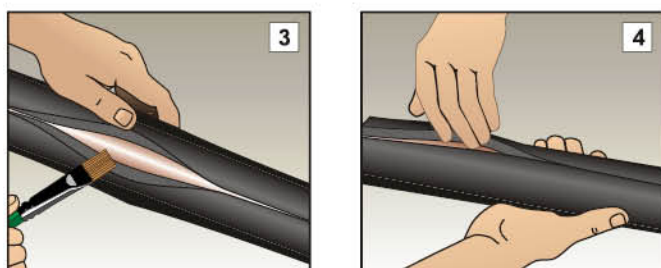

6. When the adhesive has dried, press insulation together to ensure a tight connection.
7. In a multi-layer insulation work, apply **ISOPIPE** where possible.

**Note**

**ISOPIPE Slit & Seal** is also available, which is pre-cut insulation with or without adhesive, for easier application.

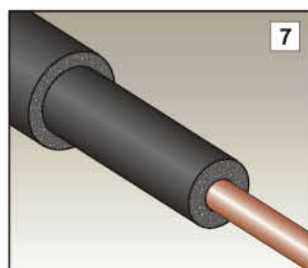

### b) Installation using ISOPIPE TC/ HT-HF/ TR Slit, ISOPIPE TC/ HT-HF/ TR Slit & Seal, ISOPIPE TC/ HT-HF SOLAR Slit & Seal

The following method is used for applying insulation on already installed and connected pipes.

**Note**

**SLIT:** Synthetic rubber installation, lengthwise pre-slitted.

**SLIT & SEAL:** Synthetic rubber installation, lengthwise pre-slitted with self-adhesive plus black overlap. It is pre-cut at angle to ensure larger bonding surface, better adhesion and less risk of heat loss. Slit & Seal reduces significantly application and installation time and costs.

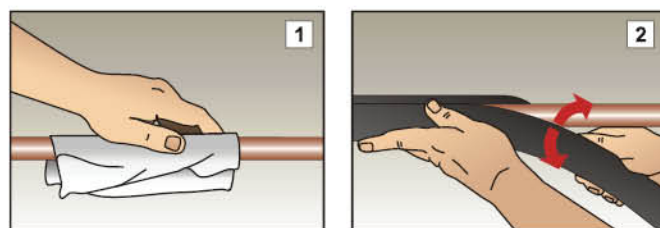

1. Clean the outside of the pipe good.
2. Clamp the insulation over the pipe.
3. Lift the inner protective release film.
4. Peel the protective release film by pulling at an angle.
5. Bring both sides of the insulation firmly together.
6. Peel release film from overlapping tape and cover the slit.
7. Apply **ISOGLUE** on the ends to align with more insulation pieces. Then press firmly together to connect them.

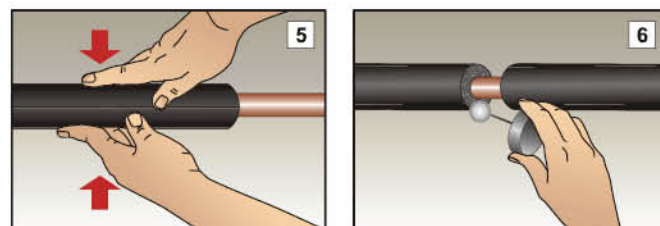

When using **Slit & Seal** with **SOLAR** protection follow the same instructions and upon finishing apply the appropriate tape (See Section 3.1.6, Page 18).

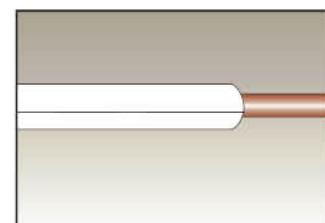

# 3.3 Fittings, Connectors

## 3.3.1 General Information

The following instructions also apply with ISOPIPE TC/ HT-HF/ TR, ISOPIPE TC/HT-HF SOLAR, ISOPIPE TC HP, ISOPIPE TC/HT-HF UV PLUS, ISOPIPE TC/HT-HF HD.

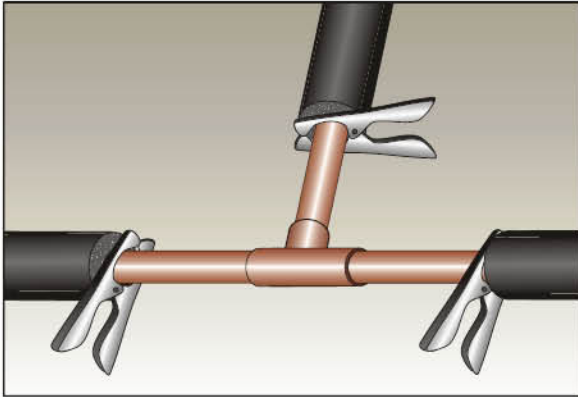

1. Bring the insulated-pipes sections together to be soldered- fitted.
2. Gently pull back the insulation and hold away with clamps, apply clamps on pipes and never on insulation.
3. Solder or fit pipes
4. After fitting has cooled, remove clamps and bring insulation back to position
5. Test the line
6. Apply joint over fitting and join with **ISOGLUE**. See forming Joints

For 90 degree bends, T-Joints and all other joints, cut, slit and form shape of joint (right angle, T-joint etc), glue joint together and with main pipe insulation.

## 3.3.2 T-Joints

The following method is used for applying insulation on already installed and connected pipes.

For similar dimension pipes, soldered joints or sweat fittings.

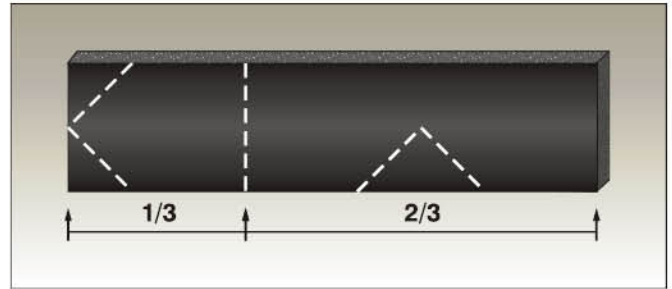

1. Separate by cutting from the same pipe a 1/3 length.
2. From the short length cut a 45% point.
3. From the long length cut a 45% indent.
4. Apply glue on the angled cut ends of both lengths, allow to touch dry, and form the T-Joint.
5. Carefully slice the T-joint in half, and place on pipes.

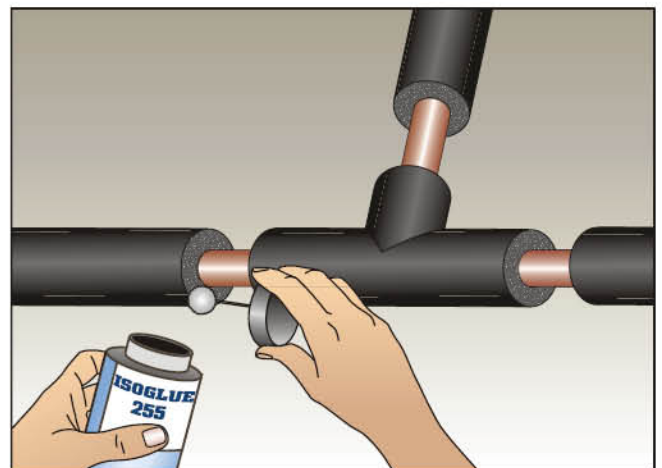
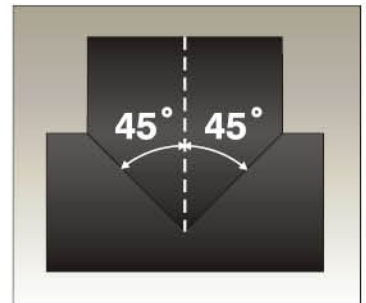

## 3.3 Fittings, Connectors

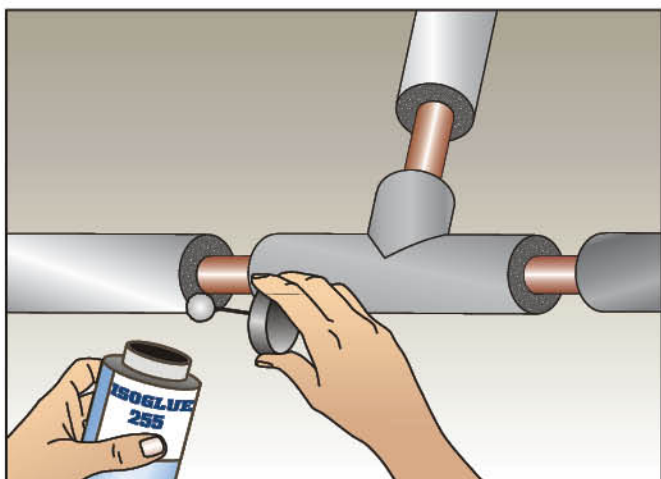
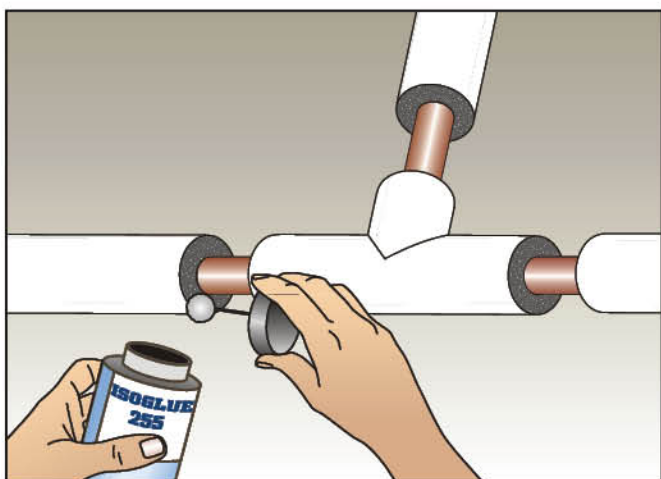

When using **SOLAR, HP, UV PLUS & HEAVY DUTY** protection follow the same instructions and upon finishing use the appropriate tape (See Section 3.1.6, Page 18).

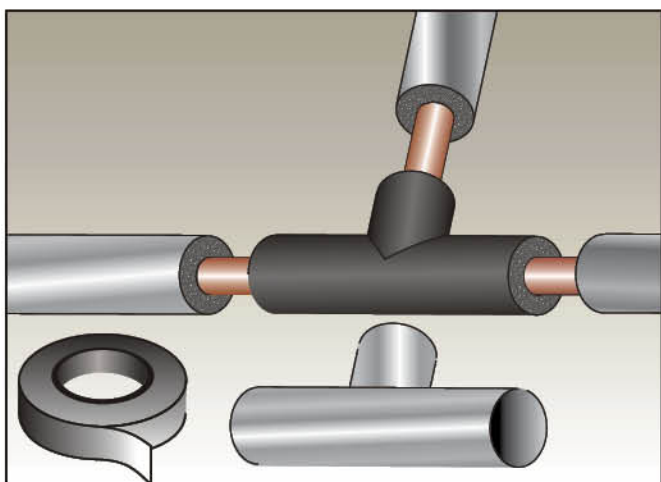

In installations where **Heavy Duty** covering is used, when having to insulate a T-joint, use **ISOPIPE TC** to insulate the joint and cover it with jacketing systems of Tees (Alu Covering) with the appropriate dimension by following the same instructions.

### Alternative method for different diameter pipes

1. With a piece of the pipe (cut-off), punch (drill) out a hole in the insulation.
2. Slice the insulation and clutch over pipe top vertical part of T-joint.
3. To join with the horizontal pipe, cut a indented curve from the insulation, with a sharp knife.
4. Slice insulation if necessary.
5. Apply glue on ends and allow to touch dry.
6. Bring horizontal insulation to meet with vertical insulation.

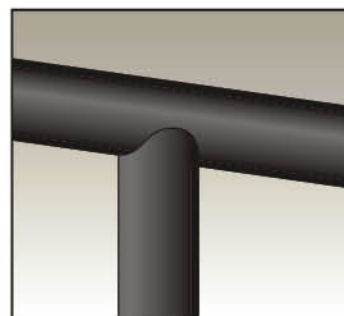
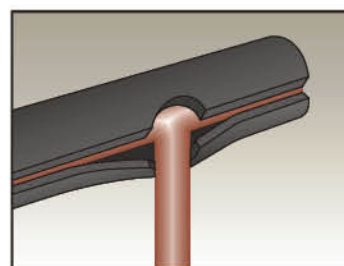
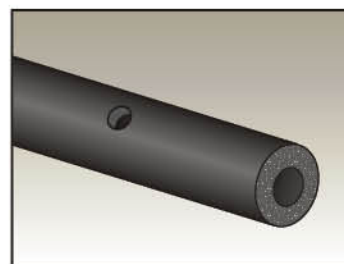

### 3.3.4 Bends

*The following instructions also apply with ISOPIPE TC/ HT-HF/ TR, ISOPIPE TC/HT-HF SOLAR, ISOPIPE TC HP, ISOPIPE TC/HT-HF UV PLUS, ISOPIPE TC/HT-HF HD.*

Alternatively where the joints diameter is different from the pipeline or for screwed fittings.

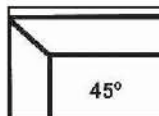

1. Bring line insulation as close as possible to joint.
2. Measure the outer diameter of the insulated pipe line (a).

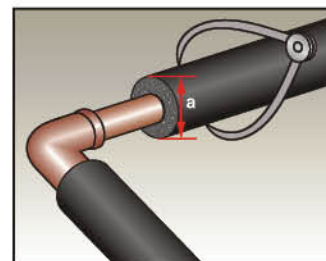



# 3.3 Fittings, Connectors

3. Choose a pipe insulation with an internal diameter to cover the insulated pipe line along with the joint.
4. Measure and cut an insulation length to cover besides the joint also the insulation and overlap it by at least 25mm.
5. Form a corner.
6. Clutch insulation over joint and insulated pipe.
7. Apply glue on end and on the overlapping surface.

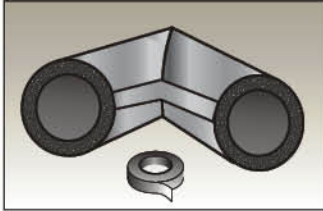
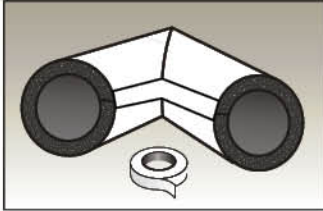
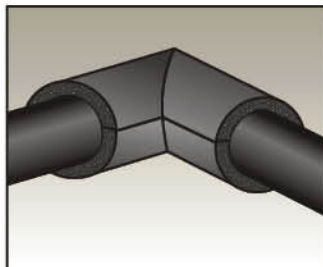
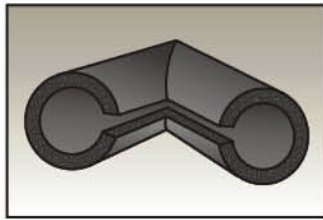
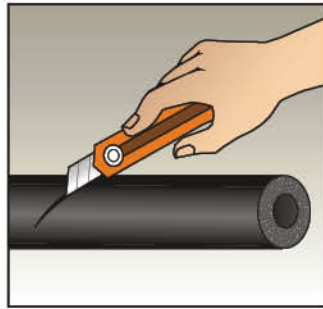

When using **SOLAR, HP, UV PLUS & HEAVY DUTY** protection follow the same instructions and upon finishing use the appropriate tape (See Section 3.1.6, Page 18).

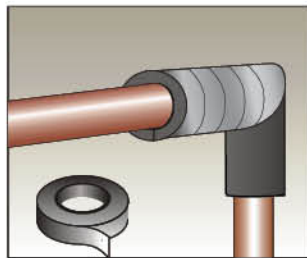

- **Bend with 45° angle**  
Yellow line shows the cut position.

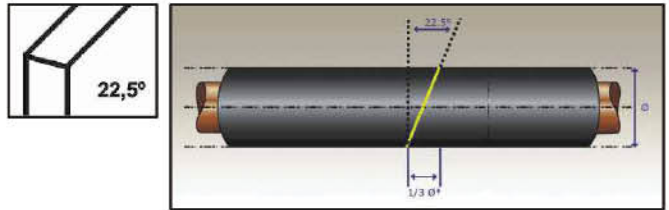

- **Segment Bend with 1 middle part (22,5°)**  
Yellow line shows the cut position.

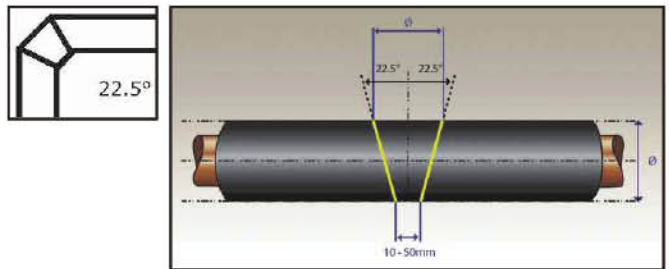

- **Segment Bend with 2 middle parts (15°)**  
Yellow line shows the cut position.

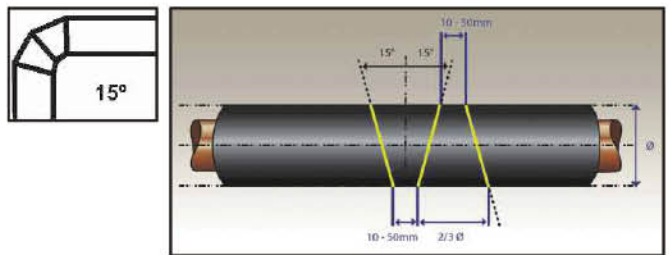

- **Segment Bend with 3 middle parts (11,25°)**  
Yellow line shows the cut position.

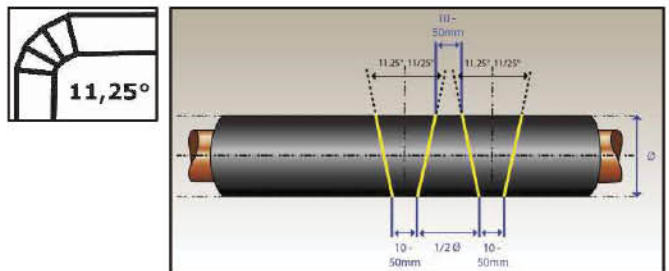

- **Crosspiece Joint**

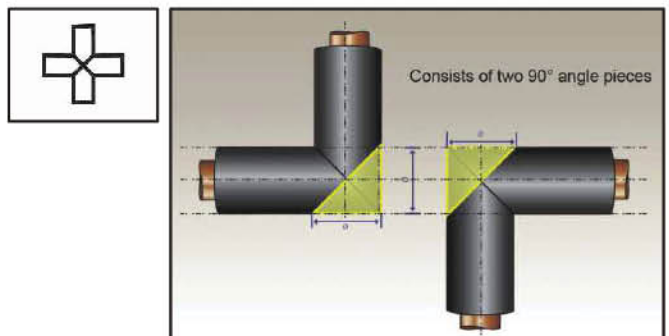

Please use the "ISOPIPE Cutting Template", which you will find printed in the back of the 2 meter ISOPIPE box, to easily create bends.



## 3.3 Fittings, Connectors

### 3.3.5 Curves

The following instructions also apply with ISOSHEET or ISOROLL TC/HT-HF, ISOSHEET or ISOROLL TC/HT-HF SOLAR, ISOSHEET or ISOROLL TC HP, ISOSHEET or ISOROLL TC/HT-HF UV PLUS, ISOSHEET or ISOROLL TC/HT-HF HD.

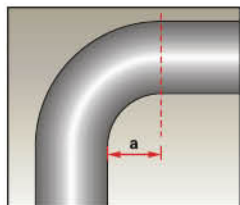

1. Measure the length of the internal curve (a).

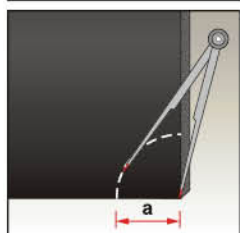

2. With the assistance of a compass, at the length of the internal curve, draw out and cut the inner arc.

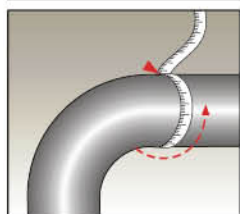

3. Measure the circumference of the pipe and mark the half point.

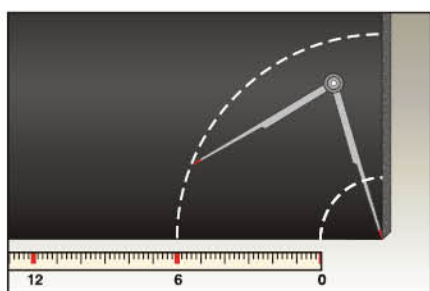
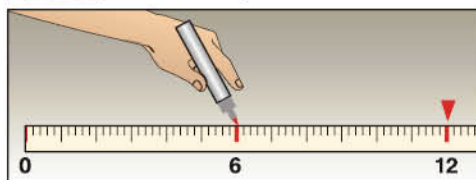

4. With the assistance of a compass, at the length of the half point of circumference, draw out and cut the outer arc.



5. Using the cut-out arche piece, carefully draw and cut another copy of the same dimension.



6. Apply glue on both ends of the long arced sides, allow to touch dry and bring pieces together, beginning from the edges.
7. Apply glue on both ends of internal arc, allow to touch dry.

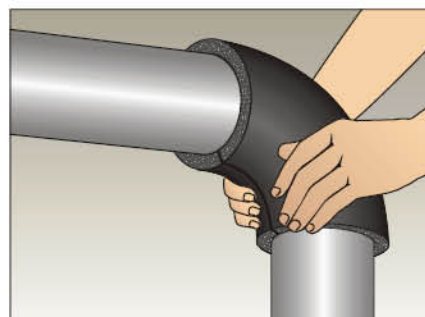

8. Bring around pipe and join.
9. Trim insulation if necessary.

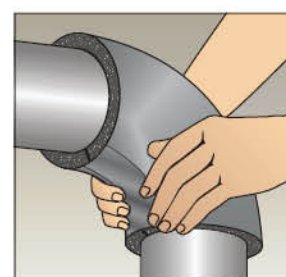
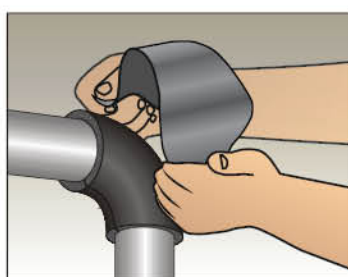

In installations where **Heavy Duty** covering is used, when having to insulate a curve, use **ISOPIPE TC** to insulate it and cover it with jacketing systems of Elbow (Alu Covering) with the appropriate dimension by following the same instructions.

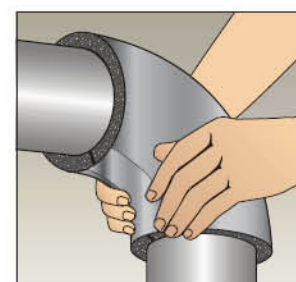

When using **SOLAR, HP, UV PLUS & HEAVY DUTY** protection follow the same instructions and upon finishing use the appropriate tape (See Section 3.1.6, Page 18).

# 3.3 Fittings, Connectors

## 3.3.6 Joints

The following instructions also apply with ISOSHEET or ISOROLL TC/HT-HF, ISOSHEET or ISOROLL TC/HT-HF SOLAR, ISOSHEET or ISOROLL TC HP, ISOSHEET or ISOROLL TC/HT-HF UV PLUS, ISOSHEET or ISOROLL TC/HT-HF HD.

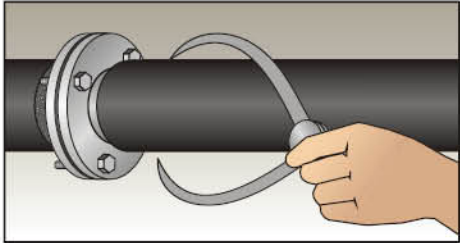

1. Bring line insulation as close as possible to flange.

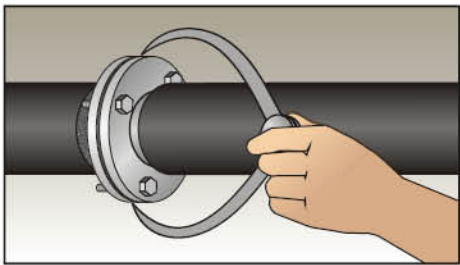

2. Measure the outer diameter of the insulated pipe line.

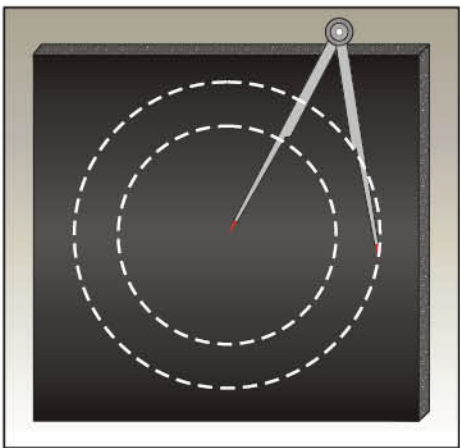

3. Measure the outer diameter of the Joint/flange.

4. With the use of a compass, draw and cut out 2 side pieces.

5. Cut an opening, and bring around pipe and adjacent to joint/flange.

6. Measure the circumference of the Joint/flange and cut.

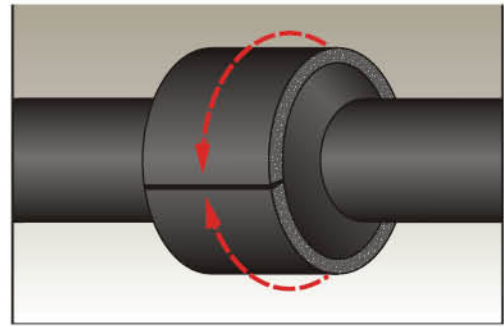
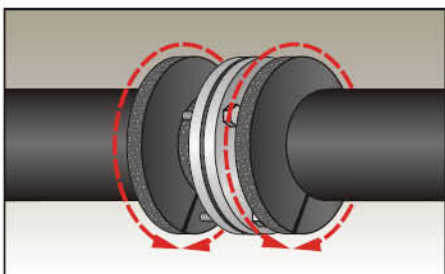

7. Measure and cut the required width to cover the joint and extend over the side pieces.

8. Apply glue on ends, allow to touch dry and bring around Joint.

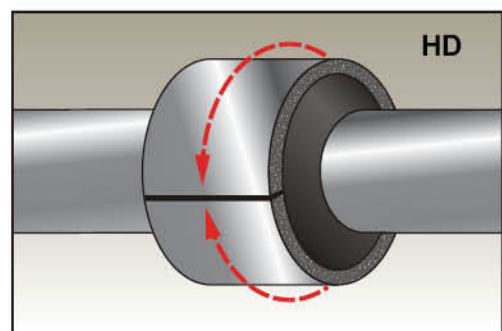
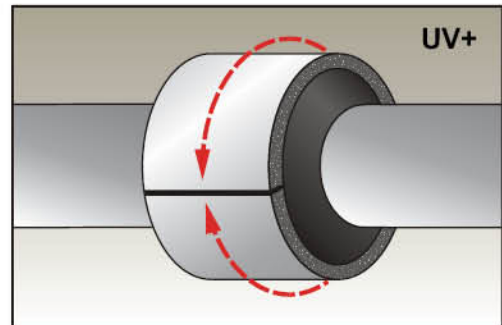
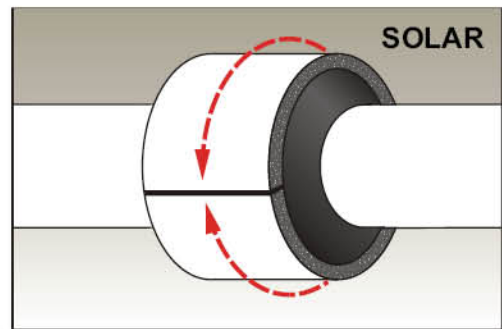

**Aluminium Tape** is considered necessary in installations that use insulation with **UV PLUS** or **HD Covering**. The tape should be applied over the glued ends/joints (See Section 3.1.6, Page 18).

## 3.3 Fittings, Connectors

### 3.3.7 Valves

The following instructions also apply with ISOSHEET or ISOROLL TC/HT-HF, ISOSHEET or ISOROLL TC/HT-HF SOLAR, ISOSHEET or ISOROLL TC HP, ISOSHEET or ISOROLL TC/HT-HF UV PLUS, ISOSHEET or ISOROLL TC/HT-HF HD.

Modifications might be needed, since shape and design may vary.

1. Cut **ISOPIPE** pieces the same diameter as the flanges and mount them on the flange and valve areas.
2. Use scrap stripes to build the body of the valve until it takes the same dimension as the flanges. Use ISOGLUE to adhere the stripes directly on the valve body.
3. Wrap a strip around the body of the flange to measure the length (A) of the sheet needed.
4. Cut the **ISOPIPE** sheet for the valve body. Length (B) is the distance between the outer edges of the pieces, located at the flanges. Cut a semicircle from each end of the sheet (C).
5. Wrap the cut out sheet around the valve body. After applying ISOGLUE, press firmly together.
6. Use next cut-out piece to insulate the bonnet area.

Take the measurements as follows:

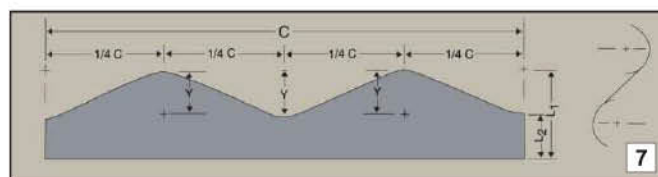
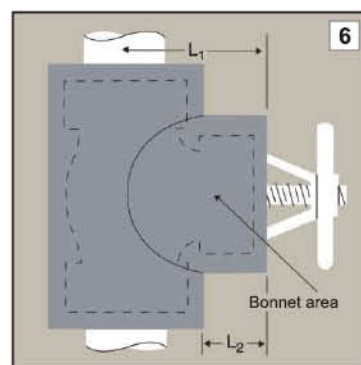
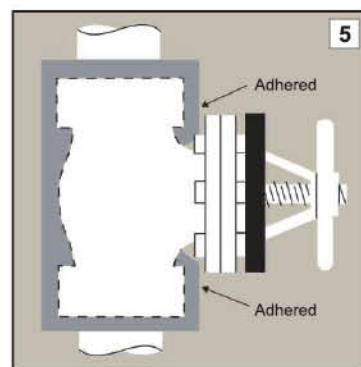
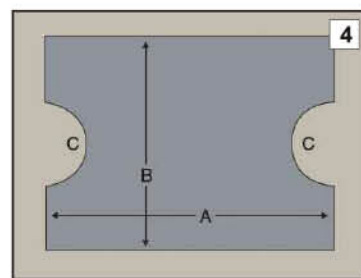
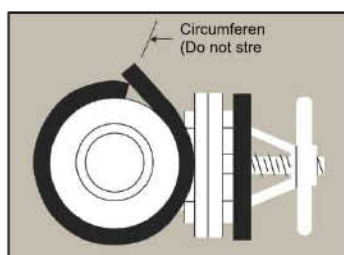
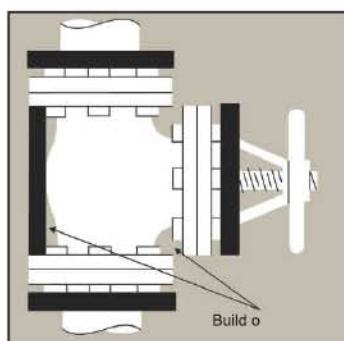
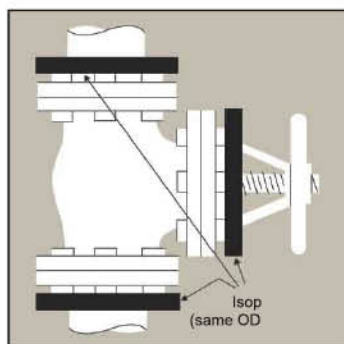

C – Overall length. Wrap a strip around the bonnet

L1 – Distance from the outer surface to the approx. middle of the valve body.

L2 – Distance from the outer surface to the closest surface of the valve body

Y – Difference between L1 – L2. Bonnet is cut in the dimension CxL1. Divide the rectangle piece in 4 equal sections and mark the short and the long length, beginning and ending from the short length. Cut carefully curving wave-like between the lengths. Apply **ISOGLUE** and wrap it around the neck of the valve. Finally, seal all the contact edges carefully.

# 3.3 Fittings, Connectors

## 3.3.8 Multilayer Insulation Pipes

The following instructions also apply with ISOPIPE TC/ HT-HF/ TR, ISOPIPE TC/HT-HF SOLAR, ISOPIPE TC HP, ISOPIPE TC/HT-HF UV PLUS, ISOPIPE TC/HT-HF HD.

1. The inside diameter of the outer overlapping pipe should be enough to cover the maximum outside diameter of the inner pipe. If the maximum diameter of the inner pipe is too large, then ISOROLLS should be used.
2. Apply glue to entire surfaces of both the inner and outer pipe; allow to touch dry before positioning.

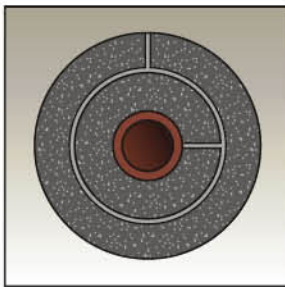

## 3.3.9 Installation On Concentric Reducers

The following instructions also apply with ISOSHEET or ISOROLL TC/HT-HF, ISOSHEET or ISOROLL TC/HT-HF SOLAR, ISOSHEET or ISOROLL TC HP, ISOSHEET or ISOROLL TC/HT-HF UV PLUS, ISOSHEET or ISOROLL TC/HT-HF HD.

1. Measure the height (h).

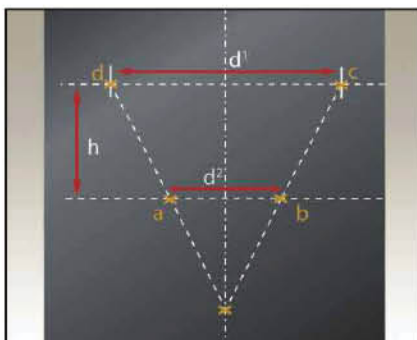
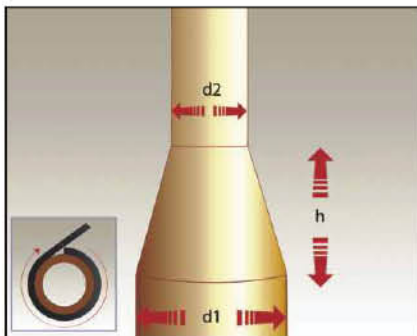

Measure the diameters of the smaller ( $d^1$  = diameter + 2x insulation thickness) and of the larger pipe section ( $d^2$  = diameter + 2x insulation thickness)

2. Mark a center line on the ISOPIPE sheet and place all the other measurement on the sheet as shown.
3. From the apex point, mark 2 arches (a-b and d-c)
4. Measure the circumference of the c1 (large pipe) and the c2 (small pipe).
5. Mark the final dimension of the insulation and cut it out.
6. Apply ISOGLUE on the cut-out edges and wrap firmly on the reducer's body.

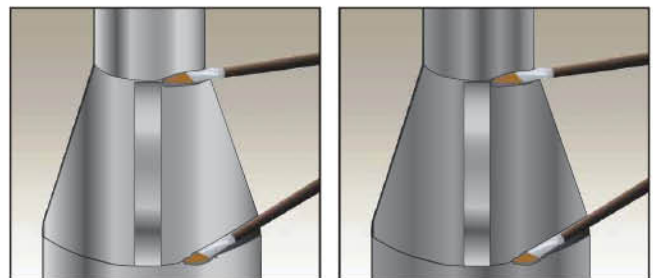
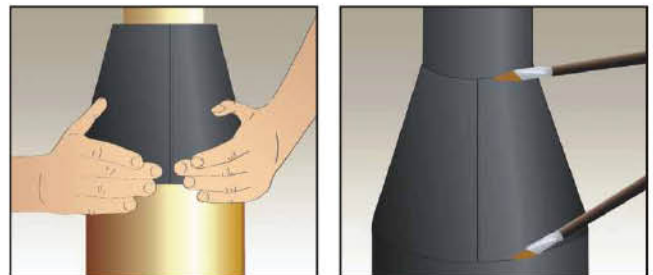
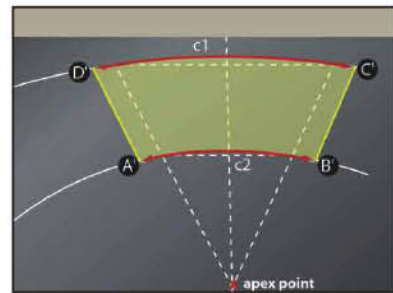
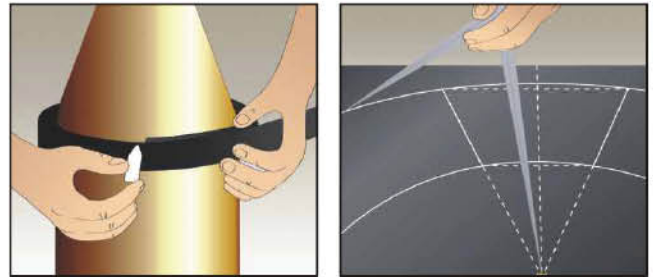

**Aluminium Tape** is considered necessary in installations that use insulation with **UV PLUS** or **HD Covering**. The tape should be applied over the glued ends/joints (See Section 3.1.6, Page 18).

## 3.3 Fittings, Connectors

### 3.3.10 Installation on Couplings

The following instructions also apply with ISOSHEET or ISOROLL TC/HT-HF, ISOSHEET or ISOROLL TC/HT-HF SOLAR, ISOSHEET or ISOROLL TC HP, ISOSHEET or ISOROLL TC/HT-HF UV PLUS, ISOSHEET or ISOROLL TC/HT-HF HD.

Insulate pipe until the coupling.

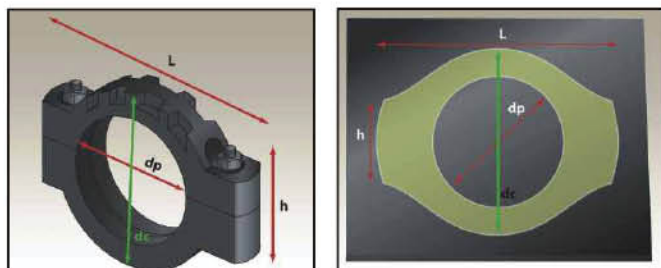

1. Measure the diameter  
( $d_c = \text{diameter} + 2 \times \text{insulation thickness}$ )  
Measure the height of screws  
( $h = \text{height} + 2 \times \text{insulation thickness}$ )  
Measure the length (L)
2. Using  $\frac{1}{2}$  of  $d_c$  as the radius transfer a circular arc to the sheet and mark a horizontal center line.

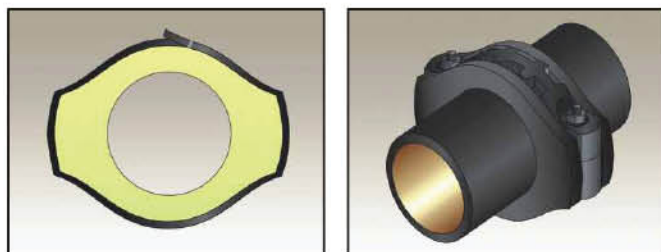

From there mark the width.  
On the ends mark the height (h) at 90° angle.  
Connect the endpoints and mark an oval.  
Mark the diameter of the pipe on the sheet to be used.  
Use template to create a second oval.

3. Apply **ISOGLUE** adhesive on both ovals.
4. Measure the circumference of the oval and the distance over the outer face of both ovals.
5. Mark them on the sheet which will be used, cut them out and wrap firmly around the coupling.



### 3.3.11 Insulation On Pipe Supports

The following instructions also apply with ISOSHEET or ISOROLL TC/HT-HF, ISOSHEET or ISOROLL TC/HT-HF SOLAR, ISOSHEET or ISOROLL TC HP, ISOSHEET or ISOROLL TC/HT-HF UV PLUS, ISOSHEET or ISOROLL TC/HT-HF HD.

Pipe supports should be also insulated, to prevent condensation.

1. Use **ISOPIPE clamp holder** with insulation
2. Glue insulation with clamp holder as normal
3. Apply clamp on the clamp holder

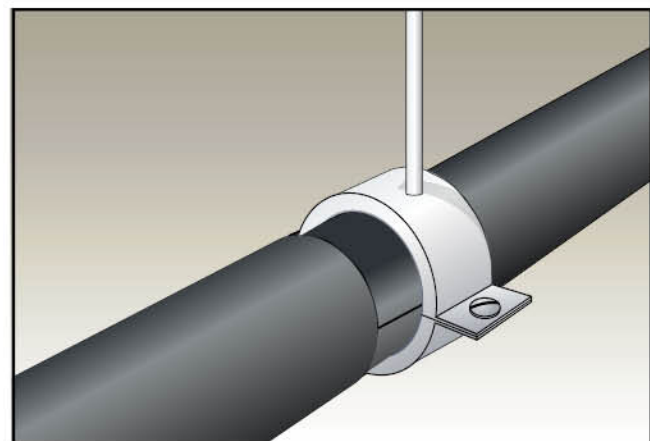
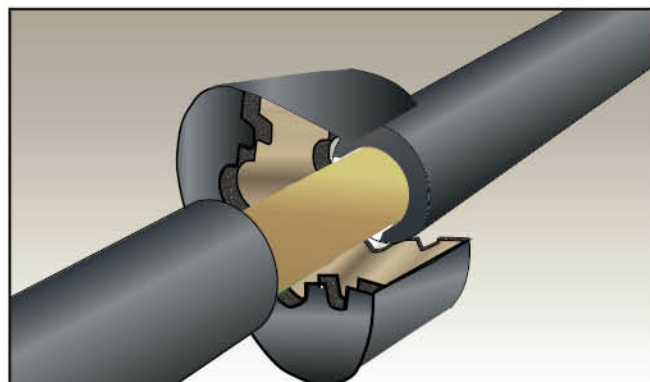

**ISOPIPE clamp holders** are available in **SOLAR, UV PLUS & HEAVY DUTY**.

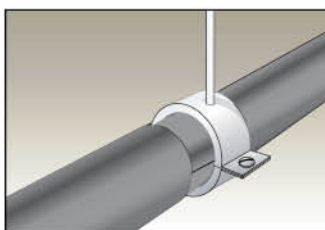
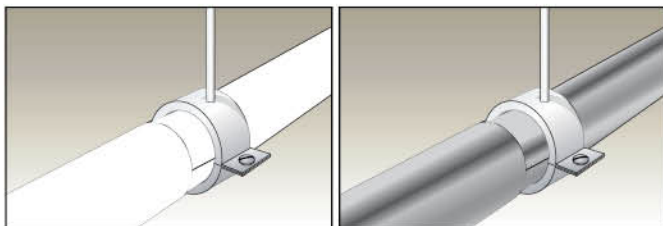

# 3.3 Fittings, Connectors

## 3.12 Installation on Strainers, Strainer Valves, Inclined Seat Valves

The following instructions also apply with ISOPIPE TC/ HT-HF/ TR, ISOPIPE TC/HT-HF SOLAR, ISOPIPE TC HP, ISOPIPE TC/HT-HF UV PLUS, ISOPIPE TC/HT-HF HD.

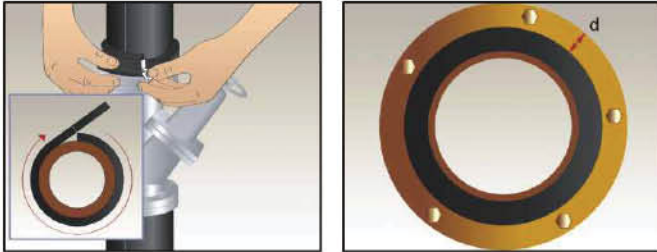

1. Insulate the pipe until the flange.
2. Measure the depth (d) of the flange ring.

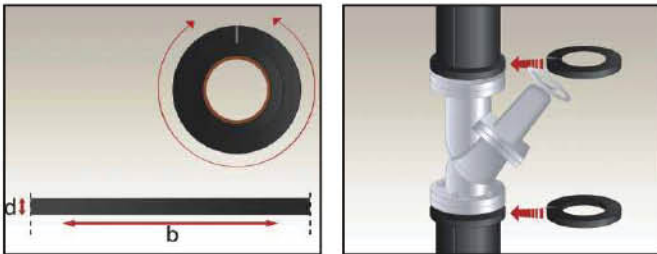

3. Measure the circumference (b) of the insulated pipe.
4. Cut the strip needed. Apply **ISOGLUE** adhesive on both sides and cover the flange ring.

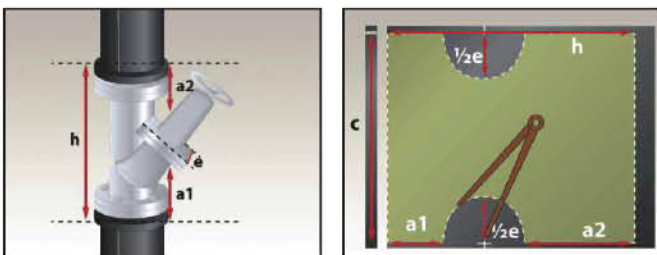

- 5.+6. Measure the distance (h), the distance a1 and a2, as well as the depth of the strainer (e) and the circumference of the rings (c).

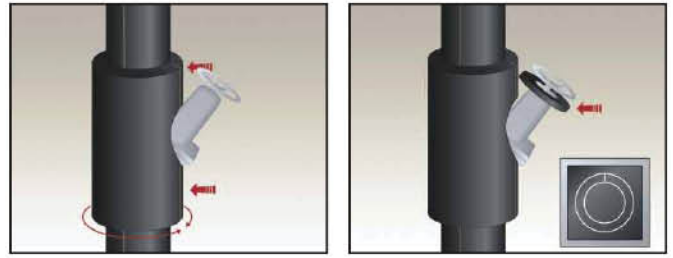

7. Transfer the results on the sheet to be used and cut-out the required piece. Apply the **ISOGLUE** adhesive on the strainer body and wrap the sheet around the strainer.
8. Cut a ring and attach it at the end of the insulated section.

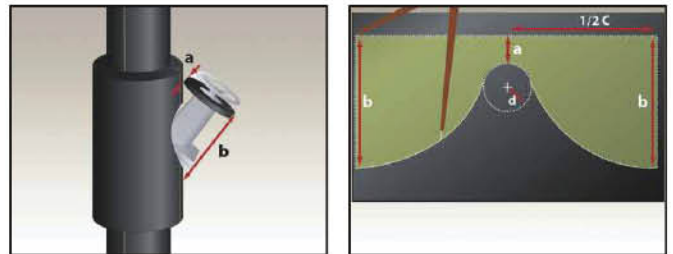

9. Measure the shortest (a) and the longest (b) distance from the ring to the strainer body.

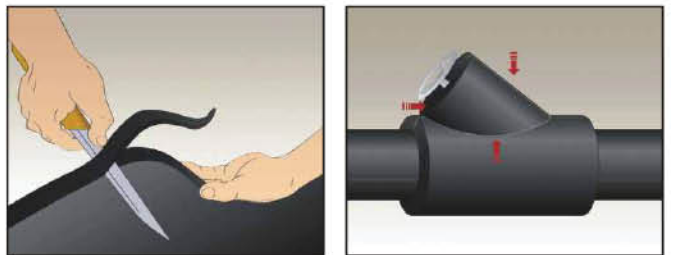

10. Measure the diameter (d) of the valve body.
11. Prepare and cut-out a sheet.
12. Apply with **ISOGLUE** and wrap around the valve body firmly.

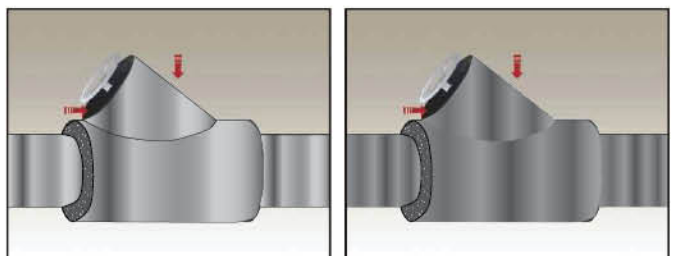

**Aluminium Tape** is considered necessary in installations that use insulation with **UV PLUS** or **HD Covering**. The tape should be applied over the glued ends/joints (See Section 3.1.6, Page 18).

## 3.4 Sheets

### 3.4.1 On Large Pipes (over 114 mm)

#### a) Installation on pipes using ISOSHEETS

The following instructions also apply with ISOSHEET or ISOROLL TC/HT-HF, ISOSHEET or ISOROLL TC/HT-HF SOLAR, ISOSHEET or ISOROLL TC HP, ISOSHEET or ISOROLL TC/HT-HF UV PLUS, ISOSHEET or ISOROLL TC/HT-HF HD.

#### Using ISOSHEETS

1. Cut the sheet to the requested width (should fit easy around the pipe).
2. Apply **ISOGLUE** adhesive on both slit surfaces. Keep the adhesive covered sides apart for drying. Wrap the sheet around the pipe and press both end sides firmly together.
3. When insulating fittings, use already designed or reusable templates.
4. The complete cover of the fitting is formed by adhering two halves together at the long outer arc. Use **ISOGLUE** on both sides. Let it dry. Press both surfaces firmly together.

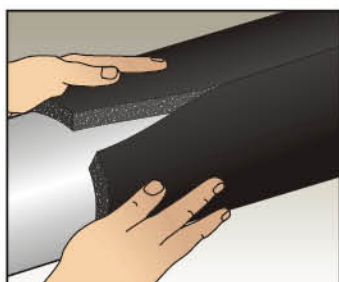
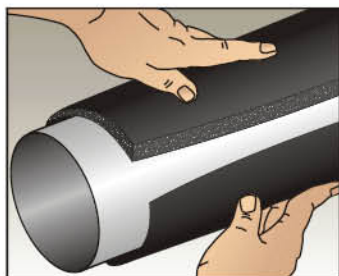

#### b) Using ISOSYSTEM (recommended for large pipes)

The **ISOSYSTEM** offers an efficient method of insulating.

45° angle cut for easy installation

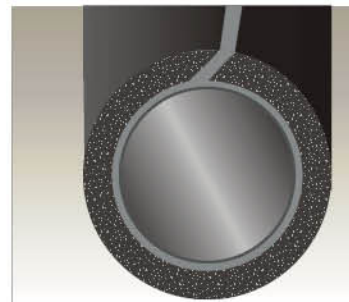

- Already pre-cut to the dimensions of the pipe. Available up to Ø 1200!

1. No need to cut the sheet.
2. Apply **ISOGLUE** adhesive on both slit surfaces. Keep the adhesive-covered sides apart for drying. Wrap the sheet around the pipe.



3. Align angle-cut edges and bring together, pressing firmly.
4. Drag palms slowly along joint, aligning and applying pressure.

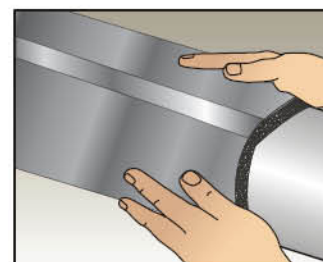
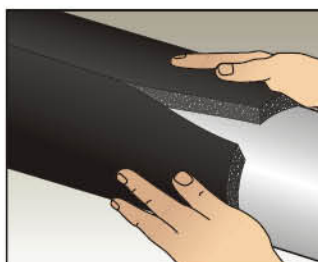

**Aluminium Tape** is considered necessary in installations that use insulation with **UV PLUS** or **HD Covering**. The tape should be applied over the glued ends/joints (See Section 3.1.6, Page 18).



## 3.4.2 On Flat Surfaces on Pipes (over 600mm using ISOGLUE)

The following instructions also apply with ISOSHEET or ISOROLL TC/HT-HF, ISOSHEET or ISOROLL TC/HT-HF SOLAR, ISOSHEET or ISOROLL TC HP, ISOSHEET or ISOROLL TC/HT-HF UV PLUS, ISOSHEET or ISOROLL TC/HT-HF HD.

It is recommended that only large thickness be used for large bore pipes.

1. Clean surfaces of insulation and surface; remove dust, water, dirt etc.
2. Measure correct dimensions length width allow an extra 5mm overlap, to allow adjacent insulation sheets to be pressed together.

For Ducts, cut the bottom side first, same width as duct, then cut the 2 side-pieces, so that they extend down over the edges of the bottom insulation. The Top piece should extend over the side insulation.

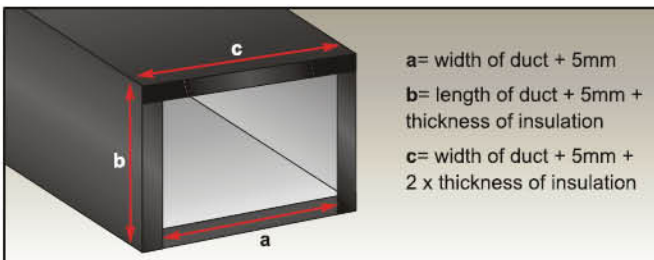

3. Apply an even layer glue, on both surfaces first the Insulation sheet and then onto metal surface, with a brush or roller.



4. Allow glue to tack dry (3-10 min)
5. Line up insulation and press firmly to achieve a good bond.
6. Fix the 2 opposite side of the duct first, then the remaining sides, taking into consideration the thickness of the sheets already installed, and also allowing for compression between adjacent sheets.
7. Apply glue on edges.



## 3.4.3 On Flat Surfaces Using Self-Adhesive ISOROLLS, ISOSHEETS

The following instructions also apply with ISOSHEET or ISOROLL TC/HT-HF, ISOSHEET or ISOROLL TC/HT-HF SOLAR, ISOSHEET or ISOROLL TC HP, ISOSHEET or ISOROLL TC/HT-HF UV PLUS, ISOSHEET or ISOROLL TC/HT-HF HD.

1. Clean surfaces of insulation and surface; remove dust, water, dirt etc.
2. Measure correct dimensions length width.

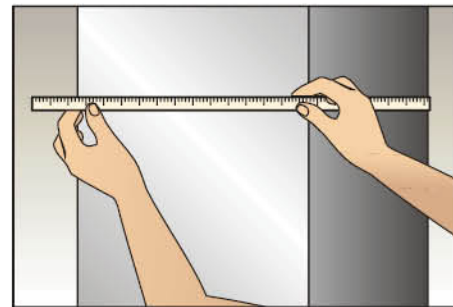

3. Peel back plastic cover.
4. Line up insulation and press firmly to achieve a good bond.

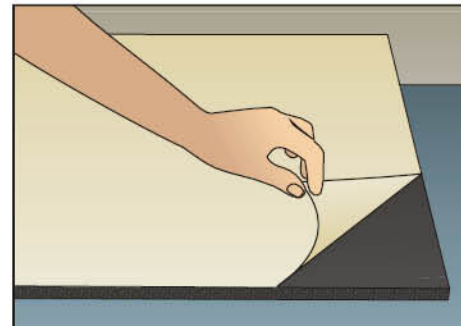

5. Keep insulation in line, pulling and removing plastic cover.
6. At joints between sheets/rolls allow an extra 5mm overlap, to allow adjacent insulation sheets to be pressed together.

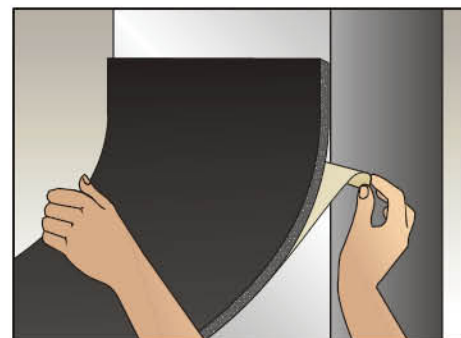

It is highly recommended, for best results to use the appropriate type of **ISOTAPE** according to the insulation's surface (See Section 3.1.6, Page 18).

**Aluminium Tape** is considered necessary in installations that use insulation with **UV PLUS** or **HD** covering. The tape should be applied over the glued ends/joints (See Section 3.1.6, Page 18).

## 3.4 Sheets

### 3.4.4 For Tanks with Dome Top

The following instructions also apply with ISOSHEET or ISOROLL TC/HT-HF, ISOSHEET or ISOROLL TC/HT-HF SOLAR, ISOSHEET or ISOROLL TC HP, ISOSHEET or ISOROLL TC/HT-HF UV PLUS, ISOSHEET or ISOROLL TC/HT-HF HD.

1. Measure, cut and apply sheet as large-bore pipes.
2. Measure the length-diameter of the oval top.
3. Cut a circle out
4. Apply glue on surface of insulation and on tank top. Also, apply glue on insulation ends.
5. Put insulation in place and press firmly on Tank and join with side-insulation.

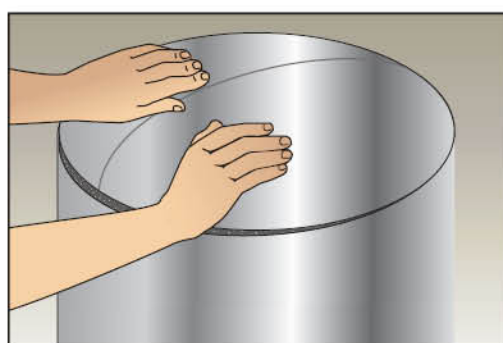
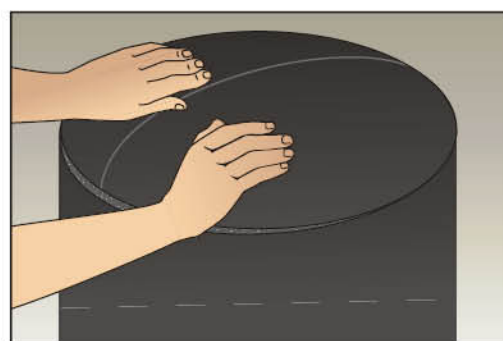
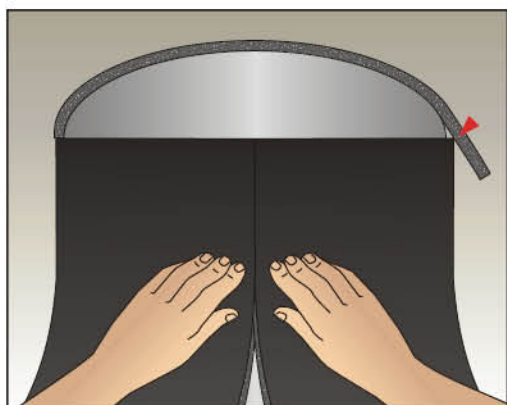

**Aluminium Tape** is considered necessary in installations that use insulation with **UV PLUS** or **HD** covering. The tape should be applied over the glued ends/joints (See Section 3.1.6, Page 18).

The information included in this instruction manual should be used as a reference guide to dealing with most common insulation application. It is up to experienced installers to identify appropriate solutions to deal with the variety and complexity of the installation.

ISOPIPE S.A. & 3i International Innovative Insulation S.A. (3i S.A.), cannot be held liable for any defects occurring as a result of incorrect or installation of the insulation. The information and pictures contained in this booklet remain the property of ISOPIPE S.A. & 3i S.A., and may not be copied or reproduced without written permission.

# ISOPIPE® S.A.

**Rebuild the future!**

[www.isopipe.eu](http://www.isopipe.eu)



## GREECE

### Head Office:

Nafpliou & Daskalogianni  
144 52 Metamorfosi Attikis  
T.: +30 210 28 28 603  
F.: +30 210 28 19 210  
E.: [export@isopipe.gr](mailto:export@isopipe.gr)

### Plant:

73rd km Nat. Road Athens -  
Lamia  
341 00 Ritsona Halkida  
T.: +30 22620 89 800  
F.: +30 22620 72 006  
E.: [export@isopipe.gr](mailto:export@isopipe.gr)



## SPAIN

### Barcelona:

C/ Costa i Deu 71 - 79  
(esq. C/ Tamarit)  
08205, Sabadell,  
Barcelona, Spain

### Madrid:

Calle Pedro Duque, 5,  
Polígono Industrial GITESA,  
28.814- Daganzo de  
Arriba (Madrid), Madrid  
Community, Spain

T.: +34 93 879 1195  
F.: +34 93 879 1313  
E.: [pedidos@isopipe.es](mailto:pedidos@isopipe.es)



## UNITED KINGDOM

### Head Office:

178 Seven Sisters Road  
London N7 7PX  
United Kingdom

### Warehouse:

Airfield Industrial Estate Warboys,  
Huntingdon  
Cambridgeshire PE28 2SH  
United Kingdom

Tel: +44 (0) 208 299 9545  
E: [orders@isopipe.eu](mailto:orders@isopipe.eu)